



Product Manual

*The Essential Guide for
Safety Teams and
Instrument Operators*

Edition 3

March 23, 2016

Part Number: 17156830-1

INDUSTRIAL
SCIENTIFIC

Industrial Scientific Corporation, Pittsburgh, PA USA

Industrial Scientific Co., Ltd. Shanghai, China

© 2015, 2016 Industrial Scientific Corporation

All rights reserved. Published 2016.

Revision 1



www.indsci.com/ventispro

Contents

General Information	1
Certifications	1
Warnings and Cautionary Statements	2
Recommended Practices	4
Instrument Maintenance	4
First Use	5
Wearing the Instrument	5
Remote Sampling	6
Cold-weather Operation	6
Product Information	7
Overview	7
Key Features	7
Compatibility	8
Sensors	8
Batteries	10
Specifications	11
Instrument	11
Battery Specifications	12
Sensor Specifications	12
Getting Started	21
Unpacking the Instrument	21
Hardware Overview	22
Display Overview	24
Power On	30
Power Off	33
Settings	35
Guidelines	35
Accessing and Protecting Settings	35
Settings Menus	36
Examples for Working in Settings	36
Reviewing and Editing Settings	38
Maintenance menu	39
Start-up menu	41
Operation menu	42
Alarm menu	43
Sensor menu	45
Admin Menu	46
Operation	49

The Instrument Buttons	49
The Instrument Display	50
Operating the Instrument	50
Information	50
Utilities	50
Wearing the Instrument	52
Alarms and Warnings At-a-glance	52
Alarms	52
Warnings	53
User-site Assignments	54
Alarms, Warnings, and Other Notifications	55
Overview	55
Alarms	55
Warnings	58
Indicators	59
Failures and Errors	59
Maintenance	61
Guidelines	61
Process At-a-glance	61
Supplies and Preparation	62
Instruction	63
Service and Warranty	67
Service	67
Guidelines	67
Supplies	67
Instruction	68
Warranty	77
Limitation of Liability	77
Assignments	79
Introduction	79
iAssign Overview	79
Procedures	81
Appendix	85
Supplemental Information about Gases and Sensors	85
Toxic Gases	85
Combustible Gases	86
Contact Information	Back cover

Tables and Figures

Table 1.1 Hazardous area certifications	1
Table 1.2 Wireless certifications	2
Table 1.3 Warnings and cautionary statements.....	2
Table 1.4 Recommended frequencies for instrument maintenance	5
Figure 2.1.A Sensor compatibility and installation locations for the Ventis Pro4	9
Figure 2.1.B Sensor compatibility and installation locations for the Ventis Pro5	9
Table 2.1 Sensor compatibility and installation locations.....	10
Table 2.2 Battery compatibility.....	10
Table 2.3 Instrument and pump specifications	11
Table 2.4 Battery specifications	12
Table 2.5 Sensor specifications	13
Table 3.1 Package contents	21
Figure 3.1.A Hardware overview diffusion instrument	22
Figure 3.1.B Hardware overview aspirated instrument	23
Figure 3.2.A Reading the display during operation.....	25
Figure 3.2.B Reading the display during an event (warning or alarm).....	26
Figure 3.2.C Reading the display during maintenance	27
Figure 3.2.D Reading the display while working in settings	28
Figure 3.3 Power on.....	32
Figure 3.4 Power off.....	33
Table 4.1 Settings menus	36
Figure 4.1.A Example for editing a single-item setting.....	37
Figure 4.1.B Example for editing a multi-item setting	38
Figure 4.2.A Navigating and using maintenance options.....	40
Figure 4.2.B Navigating and editing start-up settings	41
Figure 4.2.C Navigating and editing operation settings	43
Figure 4.2.D Navigating and editing alarm settings	44
Figure 4.2.E Navigating and editing sensor settings.....	45
Figure 4.2.F Navigating and editing admin settings.....	47
Figure 5.1 Using the buttons during operation.....	49
Figure 5.2 Home	50
Figure 5.3 Operation instruction.....	51
Figure 5.4 Using iAssign tags	54
Table 6.1 Alarm events (list)	56
Figure 6.1 Alarm events (display screens).....	57
Table 6.2 Warning events (list)	58
Figure 6.2 Warning events (display screens).....	59
Table 6.3 Failures and errors.....	59
Table 6.4 Critical errors.....	60

Figure 7.1 Maintenance supplies and preparation.....	62
Table 7.1 Calibration failure: possible causes and recommendations.....	66
Figure 8.1 Instrument diagram.....	68
Figure 8.2 Pump module diagram.....	69
Table 8.1 Instrument and pump module parts list.....	69
Figure 8.3 Service Tasks	76
Table 9.1 iAssign functionality	82
Table A.1 Cross-sensitivity guidelines (%).....	85
Table A.2 LEL correlation factors for the sensors 17155304-K, -L, and -M.....	86
Table A.3 LEL correlation factors ^a for the sensor 17155304-U	87

General Information

Certifications

Warnings and Cautionary Statements

Recommended Practices

Certifications

Instrument certifications at the time of this document's publication are listed below in Tables 1.1 and 1.2.

Table 1.1 Hazardous area certifications

Certifying Body (CB)	Area Classifications or Identification Number	Approved Temperature Range
ATEX	Equipment Group and Category II 1G, Ex ia IIC, with the protection category Ga, in the Temperature Class T4	-40 °C to +50 °C (-40 °F to +122 °F)
	Equipment Group and Category II 2G, Ex d ia IIC, with the protection category Gb, in the Temperature Class T4, with IR sensor	
CSA ^a	Class I, Division 1, Groups A, B, C, and D, in the Temperature Class T4	-40 °C to +50 °C (-40 °F to +122 °F)
	Class I, Zone 1, Ex d ia IIC, in the Temperature Class T4	
	C22.2 No. 152 applies to %LEL reading for the sensor Part Number 17155304-M only	-20 °C to +50 °C (-4 °F to +122 °F)
IECEX	Class I, Zone 0, Ex ia IIC, with the protection technique Ga, in the Temperature Class T4	-40 °C to +50 °C (-40 °F to +122 °F)
	Class I, Zone 1, Ex d ia IIC, with the protection technique Gb, in the Temperature Class T4, with IR sensor	
UL	Class I, Division 1, Groups A, B, C, and D, in the Temperature Class T4	-40 °C to +50 °C
	Class II, Division 1, Groups E, F, and G, in the Temperature Class T4	(-40 °F to +122 °F)
	Class I, Zone 0, AEx ia IIC, in the Temperature Class T4	
	Class I, Zone 1, AEx d ia IIC, in the Temperature Class T4, with IR sensor	

^aThe following apply to instruments that are to be used in compliance with the CSA certification: Ventis Pro4 and Ventis Pro5 instruments are CSA certified according to the Canadian Electrical Code for use in Class I, Division 1 and Class I, Zone 1 Hazardous Locations within an ambient temperature range of T_{amb}: -40 °C to +50 °C.

- CSA has assessed only the %LEL combustible gas detection portion of this instrument (the sensor part number 17155304-M only) for performance according to CSA Standard C22.2 No. 152. Within an ambient temperature range of T_{amb} : 0 °C to +50 °C, the accuracy is $\pm 3\%$. Within an ambient temperature range of T_{amb} : -20°C up to 0°C, the accuracy is $\pm 5\%$. This is applicable only when the monitor has been calibrated to 50% LEL CH₄.

CAUTION: CSA C22.2 No. 152 requires before each day's usage, sensitivity must be tested on a known concentration of pentane or methane equivalent to 25% or 50% of full scale concentration. Accuracy must be within -0% to +20% of actual concentration. Accuracy may be corrected by referring to the zero and calibration section of the Product Manual.

ATTENTION : CSA C22.2 N°152 exige que la sensibilité de l'instrument soit testée avant l'utilisation quotidienne de l'instrument sur une concentration connue de pentane ou de méthane équivalente à 25 % ou 50 % de la concentration totale. L'exactitude doit être entre -0 % et +20 % de la concentration réelle. L'exactitude peut être corrigée en se référant à la partie concernant la mise à zéro et l'étalonnage dans le Manuel du produit.

Table 1.2 Wireless certifications

Agency	Identification
FCC	PHH-VPX
IC	20727-VPX

Warnings and Cautionary Statements

Read and understand this Product Manual before operating or servicing the instrument. Failure to perform certain procedures or note certain conditions—provided below and throughout the manual—may impair the performance of the product, cause unsafe conditions, or both.

Table 1.3 Warnings and cautionary statements









- | | |
|---|--|
|  | If it appears that the instrument is not working correctly, immediately contact Industrial Scientific. |
|  | Only qualified personnel should operate, maintain, and service the instrument. |
|  | Substitution of components may impair intrinsic safety, which may cause an unsafe condition.
Substituer des composants peut compromettre la sécurité intrinsèque, ce qui peut résulter en une situation dangereuse. |
|  | Do not use in oxygen-enriched atmospheres. If the atmosphere becomes oxygen enriched, it may cause inaccurate readings. |
|  | Oxygen-deficient atmospheres may cause inaccurate readings. |
|  | A rapid increase in a gas reading that is followed by a declining or erratic reading may indicate an over-range condition, which may be hazardous. |
|  | Sudden changes in atmospheric pressure may cause temporary fluctuations in gas readings. |
|  | Temperatures below -20 °C (-4 °F) are likely to cause decreased functionality in the instrument's display screen and man-down feature. |
|  | Sudden changes in ambient-air temperature will cause a form of sensor drift in the Carbon Monoxide/Hydrogen Sulfide (CO/H ₂ S) sensor (part number 17155306-J) that will produce temporary variations in the sensor's readings: <ul style="list-style-type: none"> • If the temperature suddenly <i>increases</i>, the CO reading will temporarily decrease and the H₂S reading may temporarily increase. |

Table 1.3 Warnings and cautionary statements

- If the temperature suddenly *decreases*, the CO reading will temporarily increase and the H₂S reading may temporarily decrease.

The readings will stabilize when the sensor has acclimated to the change in temperature. For example, if the ambient-air temperatures changes from a "room temperature" of 20 °C (68 °F) to an outdoor temperature of 0 °C (32 °F), the stabilization time is approximately 15 minutes; with smaller or larger changes in temperature, stabilization time will be shorter or longer, respectively.

Note: If the sensor is to be zeroed after a sudden change in ambient-air temperature, allow the sensor and its readings to stabilize before zeroing.



To avoid potentially inaccurate readings for some applications—monitoring for gases other than O₂, CO, CO₂, H₂S, and combustible gases [LEL/CH₄]*—only* use a leather case as a carrying case. Do not power on, operate, or power off the instrument while it is in a leather case.



Silicone and other known contaminants may damage the instrument's combustible gas sensors, which can cause inaccurate gas readings.



To support accurate readings, keep clean and unobstructed all filters, sensor ports, water barriers, and pump intake port.



Charge the instrument's battery only in nonhazardous locations using compatible accessories from Industrial Scientific.

Chargez la batterie de l'instrument uniquement dans des lieux sans danger.



Perform all instrument service tasks and maintenance procedures in nonhazardous locations only. This includes the removal, replacement, or adjustment of any part on or inside the instrument or its pump.

Exécutez toutes les procédures de service les tâches de service sur l'instrument uniquement dans des lieux sans danger. Ceci comprend la dépose d'une pièce positionnée sur l'instrument ou à l'intérieur de celui-ci, ou bien la rechange ou le réglage d'une telle pièce.



Battery contacts are exposed on battery packs when they are removed from the instrument. Do not touch the battery contacts and do not stack battery packs on top of each other.



Do not use solvents or cleaning solutions on the instrument or its components.



This equipment has been tested and found to comply with the limits for a Class A digital device, pursuant to part 15 of the FCC Rules. These limits are designed to provide reasonable protection against harmful interference when the equipment is operated in a commercial environment. This equipment generates, uses, and can radiate radio frequency energy and, if not installed and used in accordance with the instruction manual, may cause harmful interference to radio communications. Operation of this equipment in a residential area is likely to cause harmful interference in which case the user will be required to correct the interference at his own expense.

The instrument complies with part 15 of the FCC Rules. Operation is subject to the following two conditions:

- This device may not cause harmful interference.
- This device must accept any interference received, including interference that may cause undesired operation.

Changes or modification made that are not expressly approved by the manufacturer could void the user's authority to operate the equipment.



This device complies with Industry Canada license-exempt RSS standard(s). Operation is subject to the following two conditions: (1) this device may not cause interference, and (2) this device must accept any interference, including interference that may cause undesired operation of the device.

Le présent appareil est conforme aux CNR d'Industrie Canada applicables aux appareils radio exempts de

Table 1.3 Warnings and cautionary statements

licence. L'exploitation est autorisée aux deux conditions suivantes : (1) l'appareil ne doit pas produire de brouillage, et (2) l'utilisateur de l'appareil doit accepter tout brouillage radioélectrique subi, même si le brouillage est susceptible d'en compromettre le fonctionnement.

Recommended Practices

Instrument Maintenance

The procedures defined below help to maintain instrument functionality and support operator safety.

Industrial Scientific minimum-frequency recommendations for these procedures are summarized below in Table 1.4. These recommendations are provided to help support worker safety and are based on field data, safe work procedures, industry best practices, and regulatory standards. Industrial Scientific is not responsible for determining a company's safety practices or establishing its safety policies, which may be affected by the directives and recommendations of regulatory groups, environmental conditions, operating conditions, instrument use patterns and exposure to gas, and other factors.

Settings

Settings control how an instrument will perform. They are used to help ensure the instrument is in compliance with company safety policy and applicable regulations, laws, and guidelines as issued by regulatory agencies and government or industry groups.

Utilities

Maintenance procedures are known as "utilities". Utilities are used to test the instrument or its components for functionality or performance, or to clear an instrument's summary readings. Each utility is defined below.

Self-test.

The self-test is used to test the functionality of the instrument's memory operations, battery, display screen, and each alarm signal type (audible, visual, and vibration).

Bump Test (or "functional test").

Bump testing is a functional test in which an instrument's installed sensors are to be briefly exposed to (or "bumped" by) calibration gases in concentrations that are greater than the sensors' low-alarm setpoints. This will cause the instrument to go into low alarm and will indicate which sensors pass or fail this basic test for response to gas.

Zero.

Zeroing adjusts the sensors' "baseline" readings, which become the points of comparison for subsequent gas readings. During zeroing, the installed sensors are to be exposed to an air sample from a zero-grade-air cylinder or ambient air that is known—by the instrument user—to be clean air. The instrument makes no judgement about the quality of the zero-air sample; its only task is to read that air sample as clean air. Zeroing is also a prerequisite for calibration.

Calibration.

Regular calibrations promote the accurate measurement of gas concentration values. During calibration, an instrument's installed sensors are to be exposed to their set concentrations of calibration gases. Based on the sensors' responses, the instrument will self-adjust to compensate for declining sensor sensitivity, which naturally occurs as the installed sensors are used or "consumed".

Note: During calibration, the span reserve percentage value for each sensor is displayed. An indicator of a sensor's remaining life, when the value is less than 50%, the sensor will no longer pass calibration

Summary Readings.

The time-weighted average (TWA), short-term exposure limit (STEL), and peak readings can each be "cleared". When any summary reading is cleared, its value is reset to zero and its time-related setting is also reset to zero.

Table 1.4 Recommended frequencies for instrument maintenance

Procedure	Recommended minimum frequency
Settings	Before first use, when an installed sensor is replaced, and as needed.
Calibration ^a	Before first use and monthly thereafter.
Bump test ^b	Before first use and prior to each day's use thereafter.
Self-test ^c	As needed.

^aBetween regular calibrations, Industrial Scientific also recommends a calibration be performed immediately following each of these incidences: the unit falls, is dropped, or experiences another significant impact; is exposed to water; fails a bump test; or has been exposed to an over-range (positive or negative) gas concentration. A calibration is also recommended after the installation of a new (or replacement) sensor.

^bWhen redundant sensors are operating on DualSense® technology, bump testing these sensors may be done less frequently based on company safety policy.

^cThe instrument performs a self-test during power on. For an instrument that is set for always-on, the instrument will automatically perform a self-test every 24 hours. The self-test can also be completed on demand by the instrument user.

Note: The use of calibration gases not provided by Industrial Scientific may void product warranties and limit potential liability claims.

First Use

To prepare the Ventis Pro Series instrument for first use, qualified personnel should ensure the following are completed:

- Charge the battery.
- Review instrument settings and adjust them as needed.
- Calibrate the instrument.
- Complete a bump test.

Wearing the Instrument

Based on the U.S. Department of Labor's Occupational Safety and Health Administration (OSHA) definition of the breathing zone, it is recommended that the instrument be worn within a 25.4 cm (10") radius of the nose and mouth. Refer to OSHA and to other agencies or groups as needed for additional information.

Remote Sampling

When sampling with the aspirated instrument, allow time for the air sample to reach the sensors and for the sensors to respond to any gases that are present. Industrial Scientific recommends the allowance of two minutes plus two seconds for each foot of sample tubing.

Cold-weather Operation

Use caution when operating the instrument in temperatures below -20 °C (-4 °F), which can diminish display-screen legibility and man-down functionality. To help support functionality and available battery power, the following practices are recommended.

- Do not operate the instrument in temperatures that are not within the temperature ranges of the installed sensors (see "Table 2.5, Sensor specifications").
- Use a compatible, fully charged extended-run-time battery.
- Before using the instrument in the cold-weather environment, power it on a warm-up environment (approximately 20 °C [68 °F]).
- Alternately operate the instrument in the cold-weather and warm-up environments.
- Do not operate the instrument unmanned.

Product Information

Overview

Key Features

Sensor Compatibility

Specifications

Overview

The Ventis™ Pro Series portable gas monitors are used for personal protection to monitor for oxygen and a variety of toxic gases and combustible gases.

Eleven compatible sensors are available for use with the Ventis™ Pro4 Multi-Gas Monitor, which can provide readings for up to four gases. These sensors are among the 16 available for use with the Ventis™ Pro5 Multi-Gas Monitor, which can provide readings for up to five gases.

The instruments take gas readings every second and record readings-related data every ten seconds. Data are stored in the instrument data log, which has these characteristics:

- Capacity for approximately three months of readings for a unit that is on 10 hours a day and has four installed, operational sensors
- Data storage for up to 60 alarm events, 30 error events, and 250 manual calibrations and bump tests
- Downloadable using compatible accessories that are supported by iNet®, DSSAC, or Accessory Software from Industrial Scientific.

Ventis™ Pro Series instruments use a multisensory alarm-warning-indicator system comprising audible, visual, and vibration signals.

The instrument's display-screen language can be set for English, French, German, or Spanish.

Key Features

These communication-enhancing features support operator safety:

- Using iNet, DSSAC (Docking Station Software Admin Console), or Accessory Software, the safety team can provide instrument operators with customized on-screen messages. The options include a message that displays during the start-up sequence and those that display during gas events. A unique instructional message can be set for each of these events for each sensor: gas present (alert, low alarm, and high alarm), STEL, and TWA. The messaging options provide a total of 26 opportunities for the safety team to communicate specific instructions to the instrument operator.

- The panic button provides instrument operators with the ability to turn on (and off) the instrument's high-level alarm. This can alert others who are nearby that the instrument operator is in distress, someone else is in distress, or there is some concern about in-field circumstances.
- The man-down feature allows the instrument to sense when *it* has not moved. A man-down warning or alarm may indicate the instrument operator is unable to move or press the panic button, or that the instrument has become separated from its operator. Both the warning and alarm can be turned off by the instrument operator.
- Gas information screens can be set for operation-mode access for the instrument operator who needs to view setpoints for gas events and calibration gas concentrations.

Several features support safety in ways that encourage operator attention and understanding, or that aid in the prevention of operator misuse, however unintentional.

- The full-screen alarm displays easy-to-read alarm details in "large type".
- The gas-alert feature warns the instrument operator of the presence of gas in concentrations that may be approaching the instrument's alarm setpoints. Because it can be reset by the user, the alert also serves as a form of acknowledgement, prompting the instrument operator to check the display screen for gas readings and an instructional message, and to optionally turn off the alert.
- The alarm-latch feature is used to keep an alarm on after the alarm-causing condition no longer exists. This serves to sustain alarm signals, which can encourage the instrument operator to check the display screen for gas readings and an instructional message, and to optionally release the alarm latch.
- Programmed iAssign™ tags can be used by the instrument operator to assign an instrument to the user-site data on his or her tag. This can help promote a sense of ownership among instrument operators, encouraging their responsible use of the equipment.
- When used in combination with the security code feature, the instrument's always-on option can help prevent the instrument being powered off during operation.
- When the instrument is powered-off, the quick-status feature allows users to view this instrument information: installed sensors, available battery power, and instrument serial number.

These hardware features help protect and reduce damage to the instrument:

- The raised ridge helps shield the sensor ports from dirt and damage when an instrument falls or is dropped.
- The display screen is recessed to protect it from scratches and other damage.
- Rails help reduce wear from docking.

Compatibility

Sensors

Each instrument's compatible sensors can be installed in one or more specific locations as depicted in Figures 2.1 and 2.2 for Ventis Pro4 and Ventis Pro5, respectively. Table 2.1 provides the same information but in list format, which is helpful for distinguishing among sensors of the same type. For example, there are two H₂S sensors that do not share installation locations or part numbers.

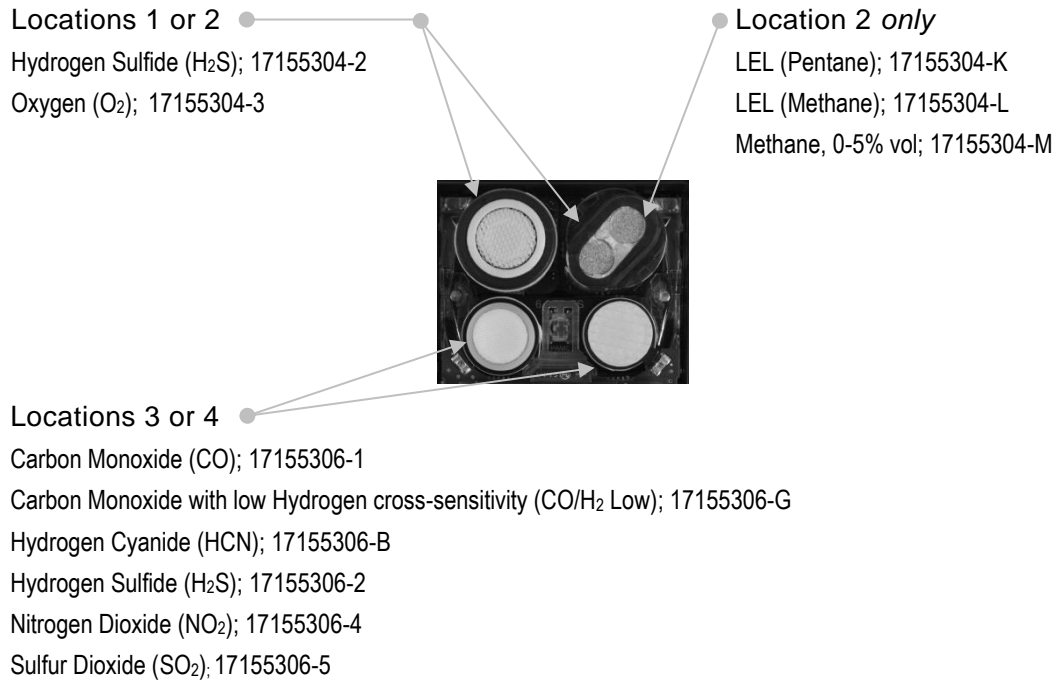

Figure 2.1.A Sensor compatibility and installation locations for the Ventis Pro4

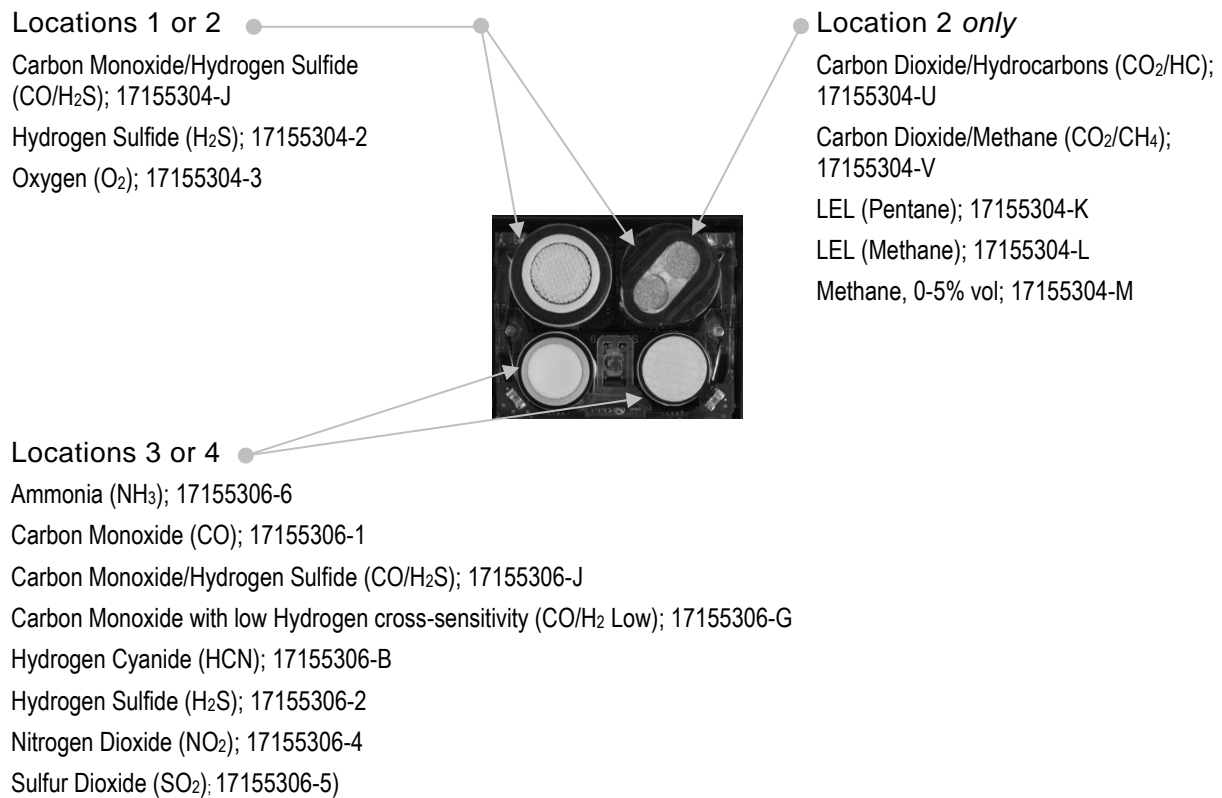

Figure 2.1.B Sensor compatibility and installation locations for the Ventis Pro5

Table 2.1 Sensor compatibility and installation locations

	Ventis Pro4	Ventis Pro5	Installation locations	Part number
<i>Sensor</i>				
Ammonia (NH ₃)	No	Yes	3 or 4	17155306-6
Carbon Dioxide/Hydrocarbons (CO ₂ /HC)	No	Yes	2	17155304-U
Carbon Dioxide/Methane (CO ₂ /CH ₄)	No	Yes	2	17155304-V
Carbon Monoxide (CO)	Yes	Yes	3 or 4	17155306-1
Carbon Monoxide/Hydrogen Sulfide (CO/H ₂ S)	No	Yes	1 or 2	17155304-J
Carbon Monoxide/Hydrogen Sulfide (CO/H ₂ S)*	No	Yes	3 or 4	17155306-J
Carbon Monoxide with low Hydrogen cross-sensitivity (CO/H ₂ Low)	Yes	Yes	3 or 4	17155306-G
Hydrogen Cyanide (HCN)	Yes	Yes	3 or 4	17155306-B
Hydrogen Sulfide (H ₂ S)	Yes	Yes	1 or 2	17155304-2
Hydrogen Sulfide (H ₂ S)	Yes	Yes	3 or 4	17155306-2
LEL (Methane)	Yes	Yes	2	17155304-L
LEL (Pentane)	Yes	Yes	2	17155304-K
Methane, 0-5% vol	Yes	Yes	2	17155304-M
Nitrogen Dioxide (NO ₂)	Yes	Yes	3 or 4	17155306-4
Oxygen (O ₂)*	Yes	Yes	1 or 2	17155304-3
Sulfur Dioxide (SO ₂)	Yes	Yes	3 or 4	17155306-5

*DualSense® technology capable.

Batteries

As shown below, the battery pack is compatible with the diffusion instrument only. The extended run-time battery can be installed for use with a diffusion or aspirated instrument.

Table 2.2 Battery compatibility

	Rechargeable Batteries	
	Part number	
	Lithium-ion battery pack	Extended-run-time Lithium-ion battery
	17134453	17148313
Compatibility		
Ventis Pro Series diffusion	Yes	Yes
Ventis Pro Series aspirated	No	Yes

Specifications

Instrument

The Ventis Pro Series' instrument specifications are provided below in Table 2.3.

Table 2.3 Instrument and pump specifications

Item	Description
Display	Monochrome LCD with automatic backlight
User interface buttons	Three (power button, enter button, and panic button)
Case materials	Polycarbonate with static-dissipative protective rubber overmold
Alarm signals	Visual (two red and two blue lights); audible (95 dB at a distance of 10 cm [3.94 "], typical ^a); and vibration
Dimensions	104 x 58 x 36 mm (4.09 x 2.28 x 1.42 ")
Weight	200 g (7.05 oz.), typical ^b
Ingress protection	IP68 at 1.5 m (4.9 ') for one hour
Pump	With 0.3175 cm (0.125 ") inside diameter sample tubing, sustains a continuous sample draw for up to 30.48 m (100 ').
Temperature range ^{c and d}	-40°C to + 50 °C (-40 °F to + 122 °F)
Humidity range ^d	15–95 % relative humidity (RH) noncondensing (continuous)

^aMay vary based on in-field conditions.

^bMay vary based on installed components.

^cTemperatures below -20 °C (-4 °F), can diminish display-screen legibility and man-down functionality. See also "Cold-weather Operation" (Chapter 1, "Recommended Practices") and Table 1.1, "Certifications".

^dSensor temperature and humidity ranges may differ from those of the instrument (see "Table 2.5, Sensor specifications").

Battery Specifications

Table 2.4 provides battery specifications, which include run time, charge time, charging temperature requirements, and expected lifetime.

Table 2.4 Battery specifications

	Rechargeable Batteries	
	Part number	
	Lithium-ion battery pack	Extended-run-time Lithium-ion battery
	17134453	17148313
Lifetime	300 charge cycles	300 charge cycles
Run time ^a	12 hours	24 hours
Charge time ^b	up to 4 hours	up to 7.5 hours
Ambient temperature required for charging	0 – 40 °C (32 – 104 °F)	0 – 40 °C (32 – 104 °F)

^aApproximate run time when the battery is fully charged and is operating at room temperature.

^bWhen a lithium-ion battery or battery pack becomes deeply discharged and the instrument is docked, it can take up to an hour for the instrument display to indicate that the battery is charging.

Sensor Specifications

Table 2.5 provides specifications for each sensor, which include properties, installation locations, operating conditions, and performance, accuracy, and response-time data.

Table 2.5 Sensor specifications

	Gas type (abbreviation)		
	Part number		
	Ammonia (NH ₃) 17155306-6	Carbon Dioxide/Hydrocarbons (CO ₂ /HC) 17155304-U ^c	
Properties			
Category	Toxic	Toxic/Combustible	
Technology	Electrochemical	Infrared	
DualSense™ capable	No	No	
Installation location			
Ventis Pro4	None	None	
Ventis Pro5	3 or 4	2	
Operating conditions			
Temperature range ^a	-20 to +40 °C (-4 to +104 °F)	-20 to +50 °C (-4 to +122 °F)	
RH range ^a	15-95%	0-95%	
Performance		CO ₂	HC
<i>Sensitivity</i>			
Measurement range	0–500 ppm	0-5% vol	0-100% LEL
Measurement resolution	1 ppm	0.01% vol	0.01% LEL
<i>Accuracy^c</i>			
Calibration gas and concentration	50 ppm NH ₃	2.5% vol CO ₂	25% LEL Propane
Accuracy at time and temperature of calibration	± 15% (0-100 ppm) 0 to 25% (101–500 ppm)	±10% or 0.1%	±5%
Accuracy over sensor's full temperature range	± 15%	±15%	±15%
<i>Response Time</i>			
T50	30 s	17 s	17 s
T90	84 s	32 s	35 s

Table 2.5 Sensor specifications

		Gas type (abbreviation)	
		Part number	
		Carbon Dioxide/Methane (CO ₂ /CH ₄)	
		17155304-V ^c	
Properties			
Category	Toxic and Combustible		
Technology	Infrared		
DualSense™ capable	No		
Installation location			
Ventis Pro4	None		
Ventis Pro5	2		
Operating conditions			
Temperature range ^a	-20 to +50 °C (-4 to +122 °F)		
RH range ^a	0-95%		
Performance	CO ₂	CH ₄	
<i>Sensitivity</i>			
Measurement range	0–5% vol	0–5% vol	5.01-100% vol
Measurement resolution	0.01% vol	0.01% vol	0.1% vol
<i>Accuracy^c</i>			
Calibration gas and concentration	2.5% vol CO ₂	2.5% vol	99% vol
Accuracy at time and temperature of calibration	± 10%	± 10%	± 10%
Accuracy over sensor's full temperature range	± 15%	± 15%	—
<i>Response Time</i>			
T50	17 s	15 s	15 s
T90	32 s	30 s	30 s

Table 2.5 Sensor specifications

	Gas type (abbreviation)					
	Part number					
	Carbon Monoxide (CO)	Carbon Monoxide and Hydrogen Sulfide (CO/H ₂ S)		Carbon Monoxide and Hydrogen Sulfide (CO/H ₂ S)		
	17155306-1	17155306-J		17155304-J		
Properties						
Category	Toxic	Toxic		Toxic		
Technology	Electrochemical	Electrochemical		Electrochemical		
DualSense™ capable	No	Yes		No		
Installation location						
Ventis Pro4	3 or 4	None		None		
Ventis Pro5	3 or 4	3 or 4		1 or 2		
Operating conditions						
Temperature range ^a	-40 to +50 °C (-40 to +122 °F)	-20 to +50 °C (-4 to +122 °F)		-20 to +50 °C (-4 to +122 °F)		
RH range ^a	15-95%	15-95%		15-95%		
Performance						
		CO	H ₂ S	CO	H ₂ S	
<i>Sensitivity</i>						
Measurement range	0-2000 ppm	0-1500 ppm	0-500 ppm	0-1500 ppm	0-500 ppm	
Measurement resolution	1 ppm	1 ppm	0.1 ppm	1 ppm	0.1 ppm	
<i>Accuracy^c</i>						
Calibration gas and concentration	100 ppm CO	100 ppm CO	25 ppm H ₂ S	100 ppm CO	25 ppm H ₂ S	
Accuracy at time and temperature of calibration	± 5%	± 7%	± 10 %	± 5%	0 to 7%	
Accuracy over sensor's full temperature range	± 10%	± 5%	± 10%	± 5%	± 10%	
<i>Response Time</i>						
T50	10 s	15 s	10 s	15 s	10 s	
T90	20 s	35 s	20 s	35 s	20 s	

Table 2.5 Sensor specifications

	Gas type (abbreviation)	
	Part number	
	Carbon Monoxide with low Hydrogen cross-sensitivity (CO/H ₂ Low)	Hydrogen Cyanide (HCN)
	17155306-G	17155306-B
Properties		
Category	Toxic	Toxic
Technology	Electrochemical	Electrochemical
DualSense™ capable	No	No
Installation location		
Ventis Pro4	3 or 4	3 or 4
Ventis Pro5	3 or 4	3 or 4
Operating conditions		
Temperature range ^a	-20 to +50 °C (-4 to +122 °F)	-30 to +40 °C (-22 to +104 °F)
RH range ^a	15-95%	15-95%
Performance		
<i>Sensitivity</i>		
Measurement range	0–1000 ppm	0–30 ppm
Measurement resolution	1 ppm	0.1 ppm
<i>Accuracy^c</i>		
Calibration gas and concentration	100 ppm CO	10 ppm HCN
Accuracy at time and temperature of calibration	± 5% (0-300 ppm) ± 15% (301-10000 ppm)	0 to 10%
Accuracy over sensor's full temperature range	± 15%	± 15%
<i>Response Time</i>		
T50	8 s	15 s
T90	12 s	50 s

Table 2.5 Sensor specifications

	Gas type (abbreviation)	
	Part number	
	Hydrogen Sulfide (H ₂ S) 17155304-2	Hydrogen Sulfide (H ₂ S) 17155306-2
Properties		
Category	Toxic	Toxic
Technology	Electrochemical	Electrochemical
DualSense™ capable	No	No
Installation location		
Ventis Pro4	1 or 2	3 or 4
Ventis Pro5	1 or 2	3 or 4
Operating conditions		
Temperature range ^a	-40 to +50 °C (-40 to +122°F)	-40 to +50 °C (-40 to +122°F)
RH range ^a	15-95%	15-95%
Performance		
<i>Sensitivity</i>		
Measurement range	0–500 ppm	0–500 ppm
Measurement resolution	0.1 ppm	0.1 ppm
<i>Accuracy^c</i>		
Calibration gas and concentration	25 ppm	25 ppm
Accuracy at time and temperature of calibration	± 5% (0-400 ppm) ± 7% (401-500 ppm)	± 7%
Accuracy over sensor's full temperature range	± 15%	± 15%
<i>Response Time</i>		
T50	10 s	10 s
T90	25 s	25 s

Table 2.5 Sensor specifications

	Gas type (abbreviation)		
	Part number		
	LEL (Methane) 17155304-L ^c	LEL (Pentane) 17155304-K ^c	Methane, 0-5% vol 17155304-M ^c
Properties			
Category	Combustible	Combustible	Combustible
Technology	Catalytic bead	Catalytic bead	Catalytic bead
DualSense™ capable	No	No	No
Installation location			
Ventis Pro4	2	2	2
Ventis Pro5	2	2	2
Operating conditions			
Temperature range ^a	-20 to +55 °C (-4 to +131 °F)	-20 to +55 °C (-4 to +131 °F)	-20 to +55 °C (-4 to +131 °F)
RH range ^a	15-95%	15-95%	15-95%
Performance			
<i>Sensitivity</i>			
Measurement range	0-100% LEL	0-100% LEL	0-5% vol
Measurement resolution	1% LEL	1 % LEL	0.01% vol
<i>Accuracy^c</i>			
Calibration gas and concentration	50% LEL methane	25% LEL pentane	2.5% vol
Accuracy at time and temperature of calibration	± 3% LEL (0-50% LEL) ± 5% LEL (51-100% LEL)	± 5% LEL	± 10%
Accuracy over sensor's full temperature range	± 15%	± 15%	± 15%
<i>Response Time</i>			
T50	7 s	10 s	7 s
T90	10 s	16 s	10 s

Table 2.5 Sensor specifications

	Gas type (abbreviation)		
	Part number		
	Nitrogen Dioxide (NO ₂) 17155306-4	Oxygen (O ₂) 17155304-3	Sulfur Dioxide (SO ₂) 17155306-5
Properties			
Category	Toxic	Oxygen	Toxic
Technology	Electrochemical	Electrochemical	Electrochemical
DualSense™ capable	No	Yes	No
Installation location			
Ventis Pro4	3 or 4	1 or 2	3 or 4
Ventis Pro5	3 or 4	1 or 2	3 or 4
Operating conditions			
Temperature range ^a	-20 to +50 °C (-4 to +122 °F)	-20 to +55 °C (-4 to +131 °F)	-20 to +50 °C (-4 to +122 °F)
RH range ^a	15-95%	5-95%	15-90%
Performance			
<i>Sensitivity</i>			
Measurement range	0-150 ppm	0-30% vol	0-150 ppm
Measurement resolution	0.1 ppm	0.1 ppm	0.1 ppm
<i>Accuracy^b</i>			
Calibration gas and concentration	25 ppm NO ₂	20.9% vol O ₂	10 ppm SO ₂
Accuracy at time and temperature of calibration	± 5%	± 0.3% vol	± 5% (0-20 ppm) 0 to 11% (21-150 ppm)
Accuracy over sensor's full temperature range	± 15%	± 0.2% vol	± 10%
<i>Response Time</i>			
T50	10 s	5 s	10 s
T90	20 s	15 s	25 s

^aDuring continuous operation.

^bApply when the instrument is calibrated using the stated calibration gas and concentration; accuracy is equal to the stated percentage or one unit of resolution, whichever is greater.

^cThe sensor part number 17155304-M is CSA-assessed for %LEL combustible gas detection. The following sensors are *not* CSA-assessed for combustible gas detection: part numbers 17155304-K, 17155304-L, 17155304-U, and 17155304-V.

“—” indicates no available data.

Getting Started

Unpacking the Instrument

Hardware Overview

Display Overview

Power On

Power Off

Unpacking the Instrument

The items that are shipped with the unit are listed below in Table 3.1. Each item should be accounted for during the unpacking process. If any item is missing or appears to have been damaged, contact Industrial Scientific (see back cover) or an authorized distributor of Industrial Scientific products.

Table 3.1 Package contents

Quantity	Item	Notes
1 as ordered	Ventis Pro Series instrument	Ventis Pro4 or Ventis Pro5.
1 as ordered	Battery (factory installed)	Rechargeable Lithium-ion or Rechargeable Extended-run-time Lithium-ion.
1	Suspender clip (factory installed)	—
1	<i>Final Inspection & Test Report</i>	Includes information ^a about the instrument and its installed sensors and factory calibration.
1	<i>Reference Guide</i>	Short-form instruction for powering on and using Ventis Pro Series instruments.
1 as ordered	Ventis Charger	The universal power cord includes four plugs, one each for use with US, UK, EU, and AUS receptacles.
1	Calibration cup	—
1	Calibration tubing	60.96 cm (2') of urethane tubing; 4.762 mm (3/16") ID.

^aAt the time of shipment.

Hardware Overview

The instrument's main hardware components are identified below in Figures 3.1.A and 3.1.B for the diffusion and aspirated instruments, respectively (Ventis Pro5 shown).

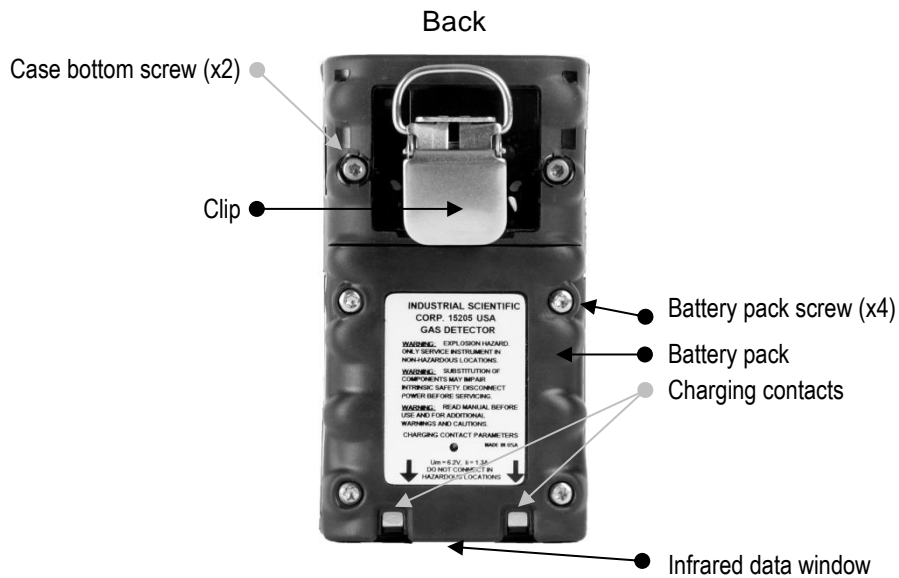
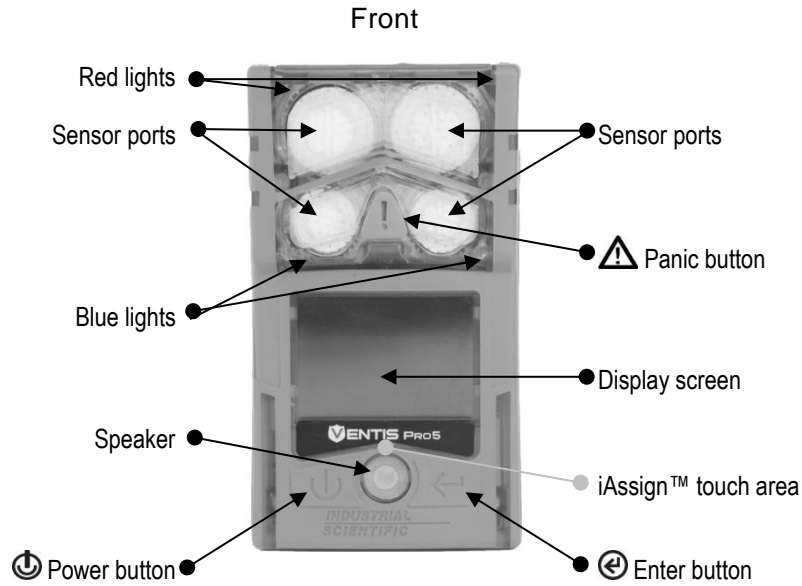

Figure 3.1.A Hardware overview diffusion instrument

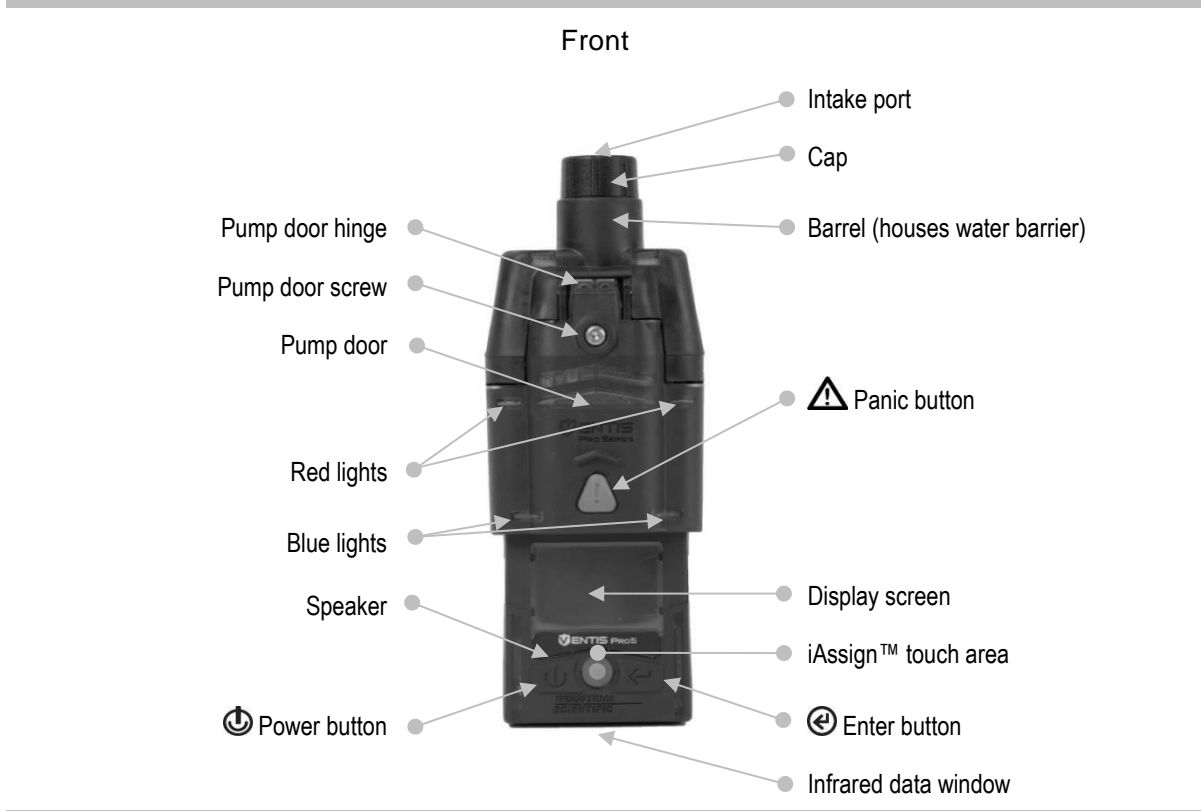

Figure 3.1.B Hardware overview aspirated instrument

Display Overview

The instrument's easy-to-read display screen has three main horizontal segments. From top to bottom, they are:

- Status bar
- Gas readings area
- Navigation bar

The instrument uses these areas to display symbols, numbers, abbreviations, and text in combinations that allow it to clearly communicate with its user: the instrument operator in the field or the safety team members who are responsible for maintaining the instrument.

See Figures 3.2.A through 3.2.D to become familiar with the display screen layout and content items the user can expect to see at these times:

- During operation
- In the event of a warning or alarm
- During maintenance
- While working in settings

Status bar

During operation, the display screen's status bar communicates basic information to the instrument operator: instrument and battery status (shown), ambient-air temperature, and the time of day.

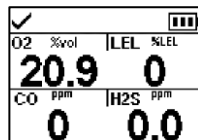

Instrument status symbol



The status bar checkmark indicates the instrument is operational.

Other symbols



Pump installed.



The battery's level of charge is between 67 and 100%.



The battery's level of charge is between 34 and 66%.



The battery's level of charge is less than or equal to 33%.



The battery's level of charge is approaching a critically low level.

11:34a

The time of day (12-hour format shown).

76 F

The ambient-air temperature reading (Fahrenheit shown).

Gas readings area

In addition to the display of current gas readings, this area communicates status information about the installed sensors.

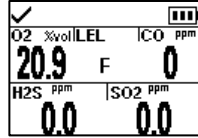

Gas reading

O2 %vol
20.9

Gas, unit of measure, and current reading.

Other symbols

F

The indicated sensor is in a general state of failure.

ØF

The indicated sensor failed zeroing.

CAL

The indicated sensor failed calibration.



BUMP

The indicated sensor failed bump testing.

ERR

The indicated sensor is installed in the wrong location.

Navigation Bar

During operation, there may be information screens or maintenance utilities available to the instrument operator. If so, the bottom area of the display screen will feature the *navigation bar*. The action displayed on the left is controlled by the button underneath it, the power button ; the action on the right is controlled by the enter button .

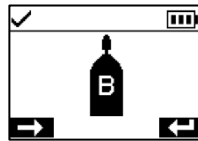

Instructional symbols and text



Start the option (bump test utility shown above).



Skip the option and go to the next display screen.

Clear

Clear values.

Figure 3.2.A Reading the display during operation

Status bar ● →
 Gas readings area ● →

In the event of a warning or alarm, the gas readings area communicates the event type, details about the alarm, and gas readings for all sensors.

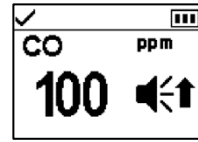
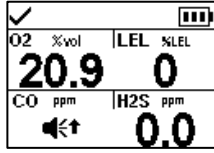

Full-screen alarm format

Event symbols (gas-related)

- and **OR** Gas present, over-range alarm
- and Gas present, high-alarm
- and Gas present, low-alarm
- Gas present, alert (warning)
- STEL** Short-term exposure limit (STEL) alarm
- TWA** Time-weighted average (TWA) alarm
- Alarm is latched

Other symbols (nongas-related, full-screen symbol)

- Critical low battery
- Panic alarm
- Man-down alarm
- ERROR**
408 System error (408 shown)

Figure 3.2.B Reading the display during an event (warning or alarm)

Status bar

The display screen's status bar indicates which maintenance procedure is in progress (bump test utility shown here).

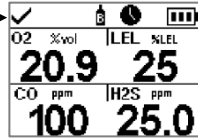

Utility symbols



Bump test utility



Zero utility



Calibration utility



Process in progress.

Gas readings area

The gas readings area communicates information about the process and results for any maintenance procedures (bump test utility shown here).

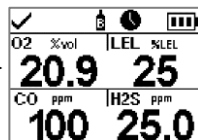

Other symbols



Calibration gas type, unit of measure, and concentration



Results



Passed



Failed

Navigation Bar

The navigation bar provides instruction. The action displayed on the left is controlled by the button underneath it, the power button (⏻); the action on the right is controlled by the enter button (↵).

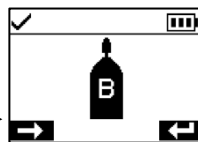

Instructional symbols



Cancel the utility (bump test shown here).



Start the utility.



Apply the calibration gas.

Figure 3.2.C Reading the display during maintenance

Status bar

When working in settings, the status bar may indicate the setting name (H₂S settings shown here).

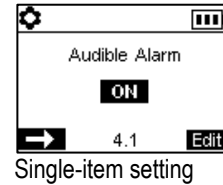
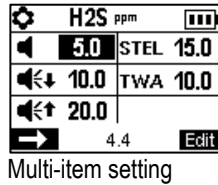

Editing area

The editing area displays the settings' values. The highlight bar indicates which setting is being edited (gas-alert value shown here).

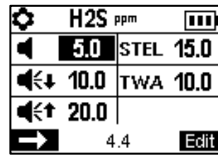

Navigation bar

The navigation bar provides instruction for navigating settings. The action displayed on the left is controlled by the button underneath it, the power button (⏻); the action on the right is controlled by the enter button (↵).

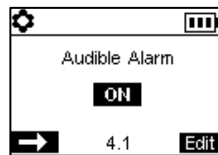

Status bar symbol



Settings.

Other symbols



Current setting.



Go to the next setting.



Edit the setting.



Edit the setting.



Scroll an options list.



Exit.

X.Y

"X" indicates the display screen's menu number; "Y" indicates its setting number.

Figure 3.2.D Reading the display while working in settings

In addition to the items described above, the Ventis Pro Series' display will also feature, when relevant, the gas names, units of measure, and other symbols shown below.

Gas names

- CH₄ CH₄ (Methane)
- CO Carbon Monoxide
- CO₂ CO₂ (Carbon Dioxide)

H2S	H ₂ S (Hydrogen Sulfide)
HC	Hydrocarbons
HCN	Hydrogen Cyanide
LEL	Combustible gases
NH3	NH ₃ (Ammonia)
NO2	NO ₂ (Nitrogen Dioxide)
O2	O ₂ (Oxygen)
SO2	SO ₂ (Sulfur dioxide)

Units of measure

ppm	Parts per million.
Mg/M ₃	Milligrams per cubic meter.
% LEL	The lower explosive level (LEL) is the minimum concentration of a gas, which, if given an ignition source, is capable of producing a flash of fire.
% vol	Percent by volume refers to a defined amount of the gas in 100 parts of air. For example, normal air contains 21% vol oxygen, or 21 parts oxygen in every 100 parts of air.

Other symbols



Yes.



No.



Maintenance due (calibration shown).



The down arrow indicates the number of *days since* the maintenance procedure was last completed. The up arrow indicates the number of *days until* the maintenance procedure is next due.



Peak readings.



User assignment.



Site assignment.



Return the instrument to Industrial Scientific.



Security code is required.



Data exchange or synchronization may be in progress.



Indicates that the sensor is operating on DualSense technology.



A sensor that was operating on DualSense has failed.



A sensor operating on DualSense is due for maintenance (sensor 1 shown here).

Power On

If a pump is installed, complete the following pump preparation steps before powering on the instrument.

If the use of the integrated pump is desired, but has not been installed, see Figure 8.2 Service Tasks.



Attach one end of the sample tubing to the pump inlet's nipple (left); attach the other end to a compatible water stop (right).

At each end, push on the tubing to ensure the connecting part is fully inserted into the tubing (approximately .635 cm [.25 "]). To test for a firm connection, gently pull on the tubing.

To power on the instrument, press and hold the power button  for approximately three seconds, until the blue lights flash. The instrument will perform a *self-test*; its operator should observe the instrument and its display screen to verify the unit is operating as expected (see Figure 3.3 below).

Immediately following the self-test is the *start-up sequence*, which will provide information and may prompt the instrument operator to prepare the instrument for use. Preparation and utility options included in the start-up sequence may vary from those shown below depending on instrument settings and whether or not a pump is installed.

At the end of the power on process, the home screen will display.

Self-test

Light test

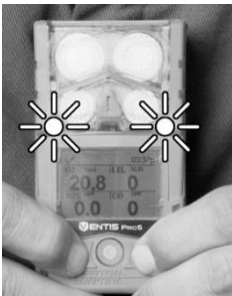

The blue lights will flash followed by the red lights. Verify that all lights are functional.

Display test

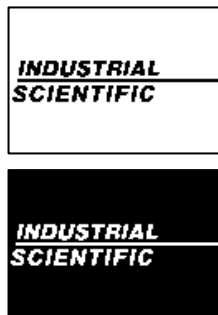

Observe the display screen to verify that all pixels are functional.

Audible and vibration test



The instrument will vibrate and then emit a loud beep. Verify that both signal types are functional.

Sample error message

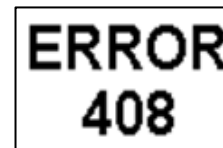

If the instrument fails any part of its self-test, an error message will display. If the instrument or its operator detect problems, contact Industrial Scientific for assistance.

Start-up sequence

Information

Date and time

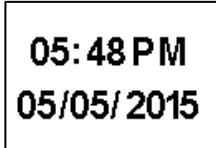

If the battery has been reinstalled or replaced, the instrument operator may be prompted to set the date and time, which can be done manually or by docking the instrument.

Instrument information



—

Regulatory information

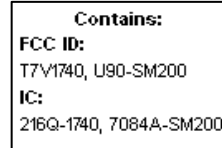

—

Instrument assignments



Indicates the company, person (user), and location (site) to which the instrument is currently assigned.

Maintenance information



The dock information (above left) indicates maintenance is due in the future ("days until").

The calibration information (above right) indicates when the maintenance was last performed ("days since"). Calibration information can also appear as due in the future.

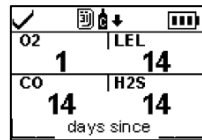

Gas information

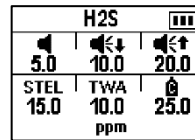

—

A series of information screens provide the setpoints for each sensor (H₂S shown). The values from left to right are:

Top row: gas present alert, low alarm, and high alarm.

Bottom row: STEL alarm, TWA alarm, and calibration gas concentration.

Verify that the settings are appropriate.

Preparation and utilities

Start-up message



Read and understand the message.



Acknowledge message.

Compliance check

(German-language instruments only)



Answer "no".



Answer "yes".



If a pump has been installed, the instrument will prompt its operator to complete the following pump test.

Pump test

Block inlet

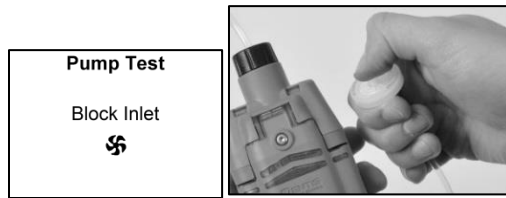

When prompted, use a thumb to block the end of the sampling line, the water-stop opening.

Wait

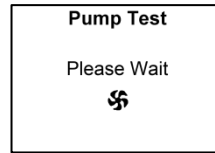

While the test is in progress, the display screen will ask the instrument operator to wait. Next, the test results will be displayed as "Passed" or "Failed".

Test results: Passed



Remove thumb from the water-stop opening.

Restart the pump: Press . It may take several seconds for the pump to restart.

Test results: Failed*

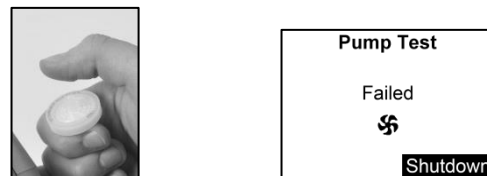

Remove thumb from the water-stop opening.

Power off the instrument.

*Note: A failed pump test may indicate a problem somewhere in the sampling line. Check and correct for cracks or other damage, debris, and improper installation in these areas: all sampling line connections, and the pump's inlet cap, inlet barrel, and dust filter.

Zero utility

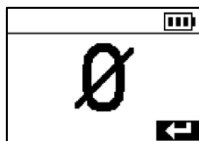

Skip the utility: wait 15 seconds.

Start the utility.

Bump test utility

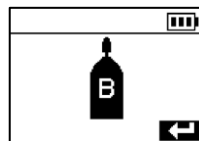

Skip the utility: wait 15 seconds.

Home

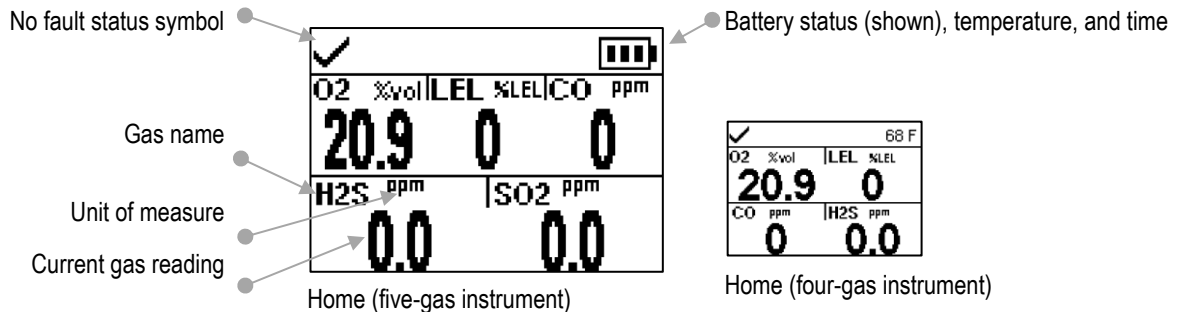

Figure 3.3 Power on

Power Off

If the instrument is set to remain on, power off may require the entry of the unit's security code.

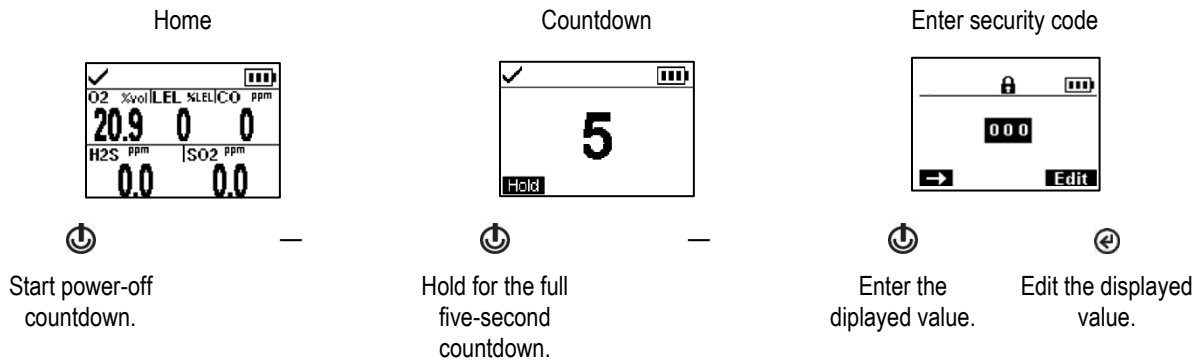

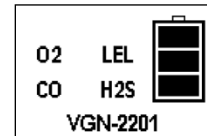

Figure 3.4 Power off

Quick-status information

When the instrument is powered off, the installed sensors, available battery power, and instrument serial number can be viewed without powering on the instrument: simultaneously press and hold  and  for two seconds.



Settings

Guidelines

Accessing and Protecting Settings

Settings Menus

Examples for Working in Settings



Reviewing and Editing Settings

Guidelines

Settings that can be adjusted manually through the instrument are described in this Product Manual. These and other settings can also be adjusted through compatible Industrial Scientific docking stations and accessories supported by iNet, DSSAC, and Accessory Software; *any changes made manually to the instrument will be overridden when the instrument is docked.*

Only qualified personnel should access and adjust instrument settings; this person is referred to below as the "safety specialist". To help guard against unintended access by nonqualified personnel, settings can be security-code protected.

Accessing and Protecting Settings

Settings can be accessed while the instrument is powering on—any time during the start-up sequence—by simultaneously pressing then releasing  and . If the security-code screen is activated, settings are protected and the instrument's security code must be entered. If the entered value matches the instrument's security code, the first settings menu (1.0 Maintenance) will display; otherwise, access to settings will be denied and the instrument will resume start-up.

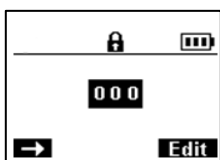

Press 
Enter the
displayed
value.

Press 
Edit the
value.

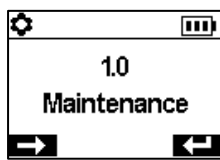

Press 
Next menu

Press 
Start
maintenance

If the code is unknown, settings can be accessed by invalidating the current security-code setting as follows: First, edit the displayed security-code value to 412. Then, simultaneously press and release Ⓢ and Ⓢ . The first settings menu (1.0 Maintenance) will display. The instrument's settings can be returned to a protected state by setting a new security code (see the settings menu 6.0 Admin).

Settings Menus

A menu system is used to organize instrument settings by topic. This allows the safety specialist to first choose the menu (topic) of interest, such as alarms, then review and optionally "edit" (adjust) each available setting within that menu. Table 4.1 summarizes the settings that are available in each menu.

Table 4.1 Settings menus

Menu number and topic	Settings summary
1.0 Maintenance	The primary purpose of the maintenance menu is to provide the safety specialist with access to maintenance procedures (utilities). The specialist can also control from here the NFC setting and make user or site assignments.
2.0 Start-up	Start-up settings allow the safety specialist to permit or prohibit all-user access—from the start-up sequence—to some utilities and maintenance status information (e.g., number of days until calibration is due).
3.0 Operation	<p>The operation menu allows the safety specialist to permit or prohibit—during instrument operation—all-user access to utilities and maintenance status information. Access is set separately for each item. For example, the option to clear the peak readings may be permitted for all-user access, but access to calibration may be prohibited.</p> <p>From here, the specialist can also permit or prohibit the use of iAssign tags during instrument operation.</p>
4.0 Alarm	<p>Alarm settings allow the safety specialist to set the values for each gas event that will cause the instrument to alarm.</p> <p>The specialist can also permit or prohibit instrument power off during alarms and make other choices about alarm-related instrument behavior.</p>
5.0 Sensor	Sensor settings allow the safety specialist to view basic information about the installed sensors and control settings related to calibration and bump test utilities.
6.0 Admin (Administration)	<p>Admin settings allow the safety specialist to control important aspects about how the instrument communicates with its operator. For example, a security code can be set to help restrict all-user access to settings.</p> <p>The safety specialist can also set the display-screen language, maintenance-related warnings, and other items.</p>

Examples for Working in Settings

Two examples are provided below to illustrate how to navigate in and adjust settings.

Each example includes a goal, a target setting that is to be changed; the navigation path that leads to the target setting; and instruction to change the target setting.

Example 1 features a single-item setting—a setting that has a value of “on” or “off”.

Example 2 features a multi-item setting where the value for each of several items can be changed—one item at a time.

Example 1. Editing a single-item setting

Goal: Latch the instrument's alarms

- From the 1.0 Maintenance menu, navigation leads to the 4.0 Alarm menu where the alarm-latch setting resides. Along the way, the navigation bypasses menus 1.0, 2.0, and 3.0.
- From the 4.0 Alarm menu, navigation leads to the setting, "Alarm Latch". Along the way, other alarm settings are bypassed and their values remain unchanged.
- At the alarm-latch setting, the value is changed from "off" to "on".

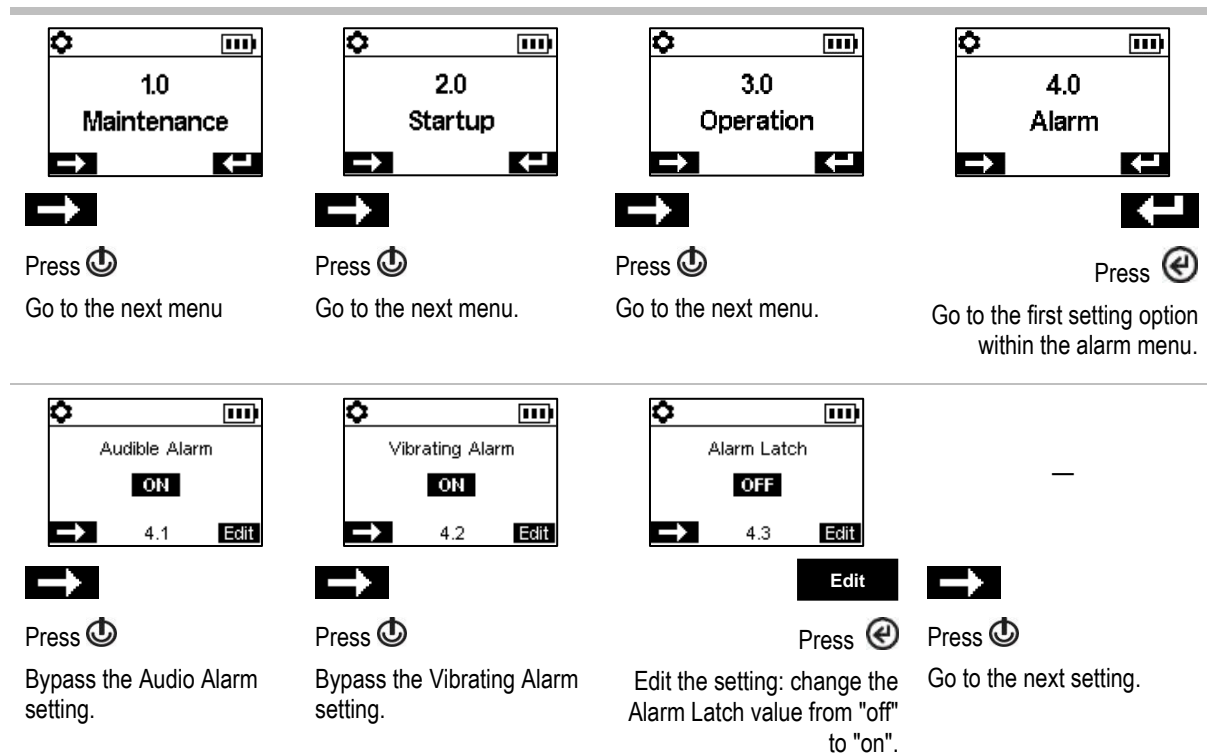

Figure 4.1.A Example for editing a single-item setting

Example 2. Editing a multi-item setting

Goal: Change the high-alarm setpoint for H₂S.

- Follow the navigation from *Example 1* above.
- The navigation shown below then bypasses setpoints for the O₂, LEL, and CO sensors are bypassed; their values remain unchanged.
- The H₂S event setpoint screen is a five-item setting. The navigation bypasses the first two settings, the gas-alert and low-alarm setpoints; their values remain unchanged.
- The H₂S high-alarm setpoint is then highlighted for editing. Its value is changed from 20.0 ppm to 19.0 ppm.

<p>Press Bypass the settings for O₂.</p>	<p>Press Bypass the settings for LEL.</p>	<p>Press Bypass the settings for CO.</p>	<p>Press Highlight the first setpoint for H₂S (gas alert).</p>

			<p>—</p>
			<p>—</p>
<p>Press Bypass the gas-alert setting.</p>	<p>Press Bypass the low-alarm setting.</p>	<p>Press Edit the value for the high-alarm setpoint. Press the button until the desired value of 19.0 is displayed.</p>	<p>Press Save the new high-alarm setpoint value; go to the next H₂S setting.</p>

		<p>—</p>	<p>—</p>
		<p>—</p>	<p>—</p>
<p>Press Bypass the STEL alarm setting.</p>	<p>Press Bypass the TWA alarm setting.</p>	<p>—</p>	<p>—</p>

Figure 4.1.B Example for editing a multi-item setting

Reviewing and Editing Settings

The rest of this chapter describes in detail the settings and options available within each menu. Instruction is provided for navigating each menu and adjusting its settings.

- Maintenance
- Start-up
- Operation
- Alarm
- Sensor
- Admin

When navigating and editing settings, the instrument will wait approximately 60 seconds between button presses; when no button is pressed, it will exit settings and re-enter start-up. To return to settings from start-up, simultaneously press and hold, then release and .

Maintenance menu

The maintenance menu serves mainly to provide the safety specialist with access to maintenance procedures (utilities), plus some general information and iAssign-related settings.



Perform any utility:

- Zero the installed sensors.
- Calibrate the instrument.
- Bump test the installed sensors.
- View and optionally reset to zero each summary reading (peak, TWA, or STEL reading). When any summary reading is reset to zero, its time-related setting is also reset to zero.

View and optionally set the instrument's user and site assignments from the list of available values.

Access this information:

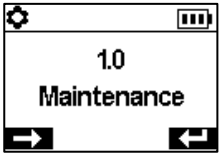
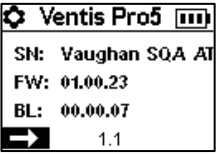
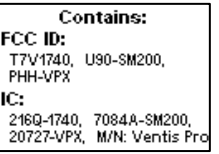
- The docking or calibration due values, or days since last calibration
- The instrument's model, serial number, firmware version, boot loader version, and regulatory information

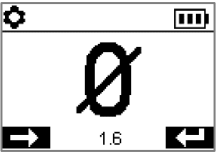
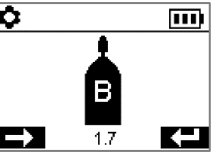
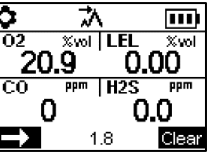
<p>Maintenance menu</p>  <p>Next menu Go to the first maintenance option</p>	<p>Instrument information</p>  <p>Next option</p>	<p>Regulatory information</p>  <p>Next option</p>	<p>Dock status</p>  <p>Next option View span values</p>
<p>Calibration status</p>  <p>Next option View span values</p>	<p>Zero and calibration utilities</p>  <p>Next option Start utility</p>	<p>Bump test utility</p>  <p>Next option Start utility</p>	<p>Peak readings</p>  <p>Next option Clear peak readings</p>

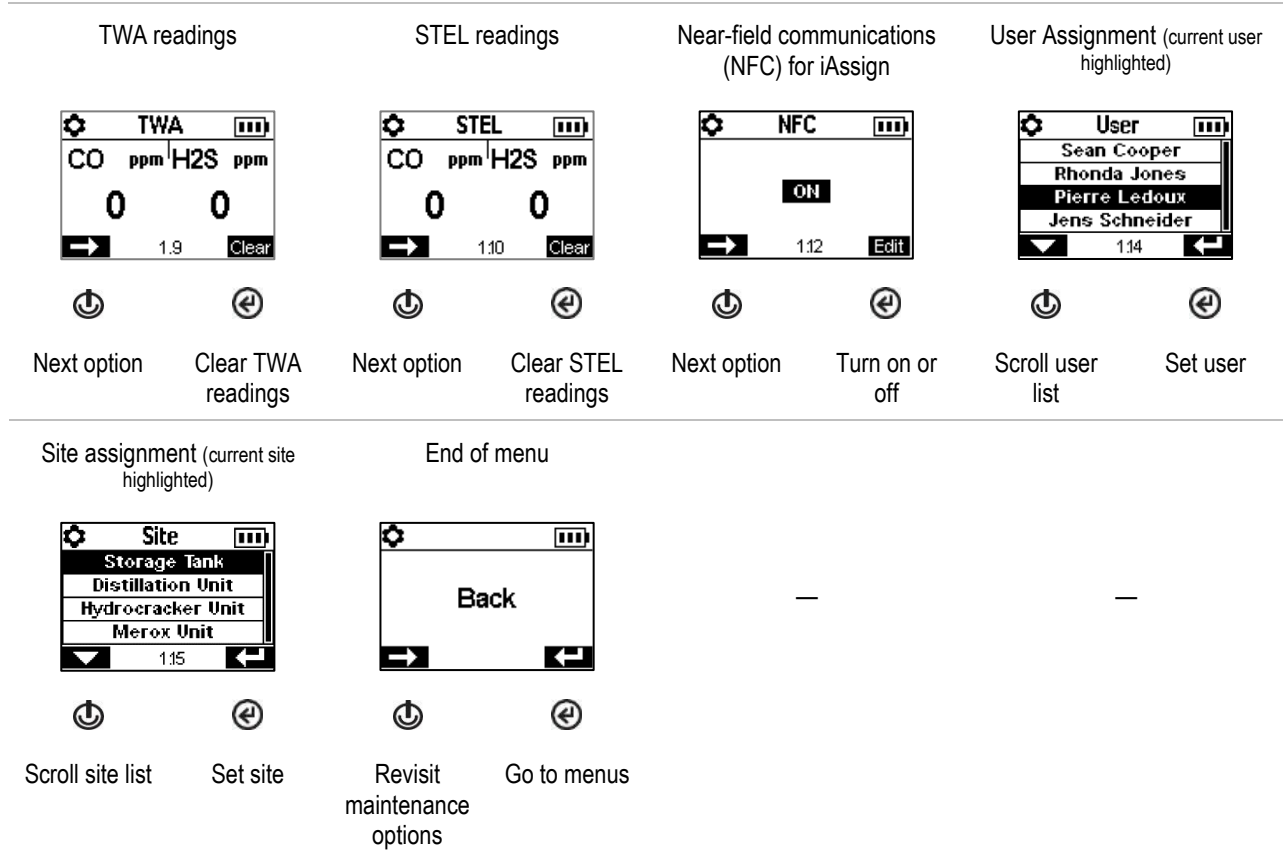

Figure 4.2.A Navigating and using maintenance options

Start-up menu

Control how the instrument will interact with its operator during start-up: permit or prohibit all-user access to each of item listed below.

Maintenance utilities:

- Zero the installed sensors.
- Bump test the installed sensors.

Maintenance status message:

- No message
- The number of days until the next dock is due
- The number of days until the next calibration is due
- The number of days since calibration was last performed

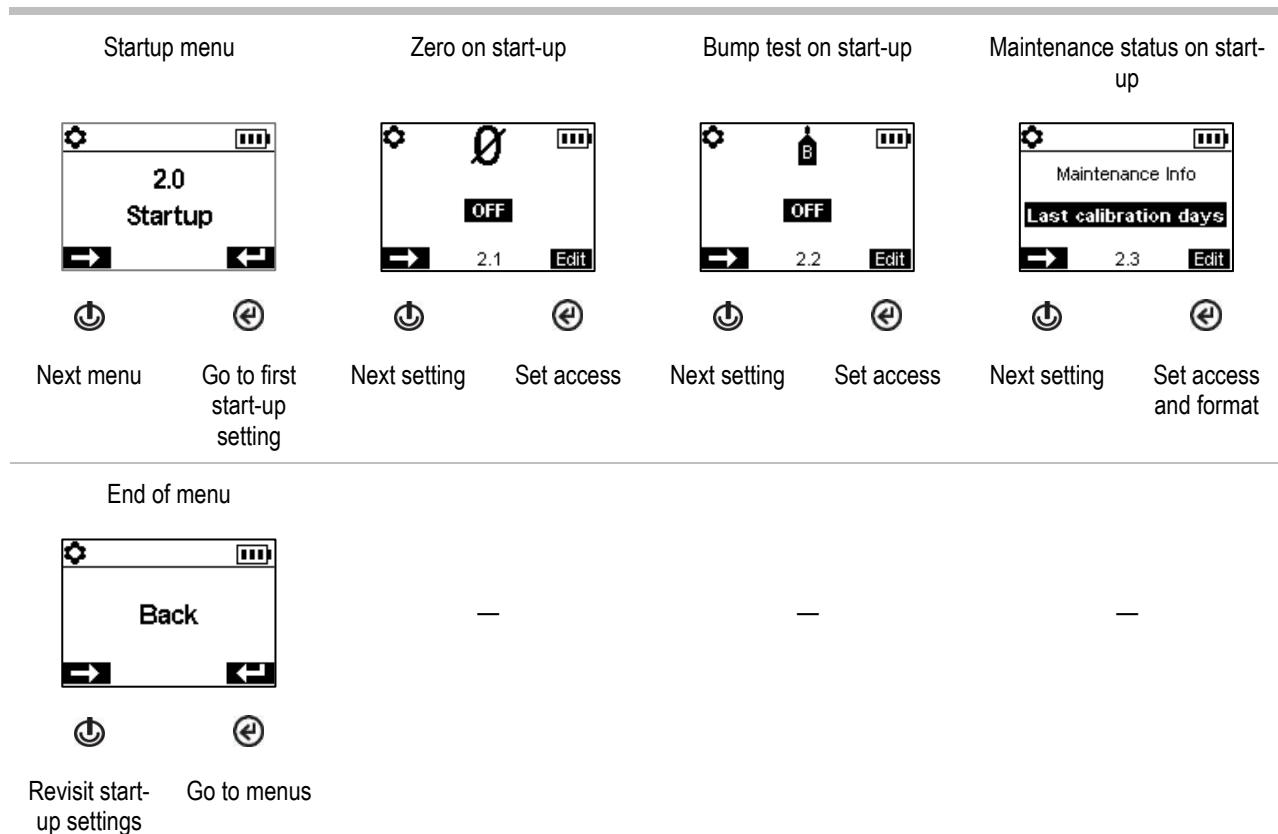

Figure 4.2.B Navigating and editing start-up settings

Operation menu

Control how the instrument will behave during operation.

Permit or prohibit all-user access, during operation, to each of the items listed below.

Utilities:

- Zero the installed sensors.
- Calibrate the instrument.
- Bump test the installed sensors.
- View and optionally clear each summary reading (peak, TWA, or STEL). *Note:* When an instrument operator clears any summary reading, the value is reset to zero and its time-related setting is also reset to zero.

Information:

- The instrument's current assignments for user, site, or both
- A maintenance message about scheduled docking or calibration activities
- The gas information for all installed sensors: the values for the gas alert and alarm setpoints, and the calibration gas and concentration

Set this functionality

- Permit all-user power off or set the instrument for "always-on" operation*.
- Permit or prohibit the use of iAssign tags during operation.
- Set the instrument to display the ambient air temperature in Celsius or Fahrenheit.

*Always-on functionality also requires a valid security code setting (see the settings menu 6.0 Admin).

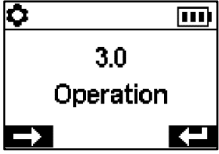
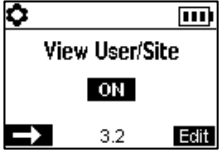
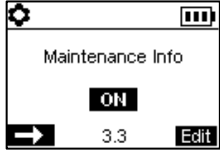
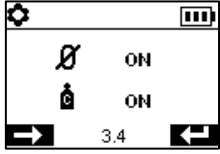
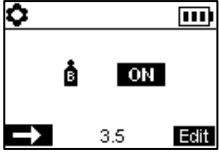
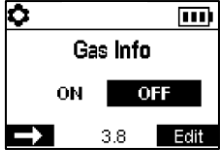
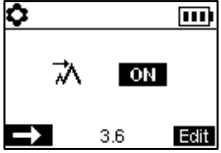
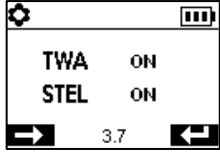
<p>Operation menu</p>  <p>Next menu Go to first operation setting</p>	<p>Instrument assignment information</p>  <p>Next setting Set all-user access</p>	<p>Maintenance status</p>  <p>Next setting Set all-user access and format</p>	<p>Zero and calibrate</p>  <p>Next setting Set all-user access</p>
<p>Bump test</p>  <p>Next setting Set all-user access</p>	<p>Clear summary readings</p>		<p>Gas settings information</p>  <p>Next setting Set all-user access</p>
<p>Peak readings</p>  <p>Next setting Set all-user access</p>	<p>TWA and STEL readings</p>  <p>Next setting Set all-user access</p>		

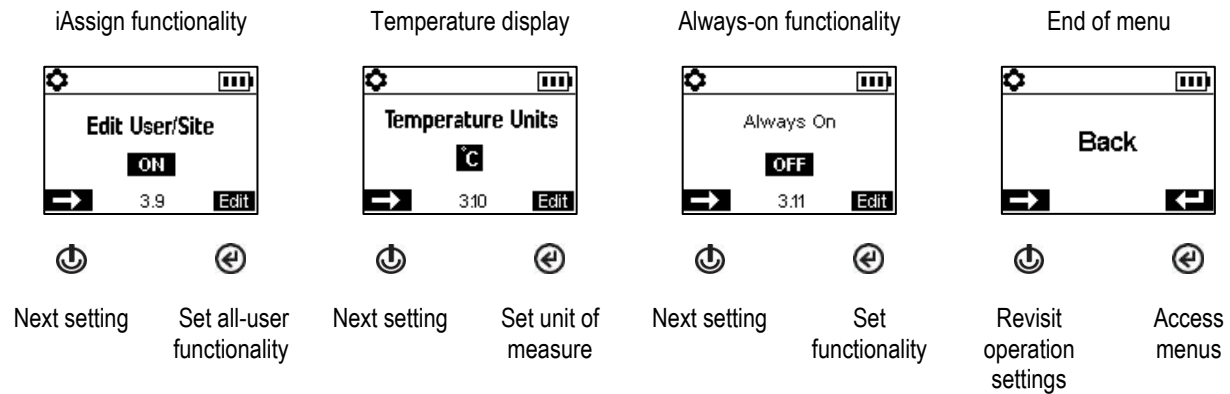

Figure 4.2.C Navigating and editing operation settings

Alarm menu

Control how the instrument will behave during alarms and some warnings.

Set for each sensor, the concentration of gas that will cause each possible gas event listed below.

- gas present, alert
- gas present, low-alarm
- gas present, high-alarm
- TWA
- STEL

Note: The navigation will start with the first event setpoint for the *first sensor*, then the second event setpoint for that same sensor, and so on through the last setpoint for the sensor. The navigation will then go through the same pattern for the *next sensor*.

Set the TWA time interval for toxic sensor readings.

Permit or prohibit instrument power off during alarms.

Set the on-off functionality for the man-down feature; set the amount of time that will lapse between the man-down warning and its alarm.

Set the on-off functionality for each option listed below.

- audible alarm
- vibrating alarm
- gas-present alert
- alarm latch
- alarms while docked

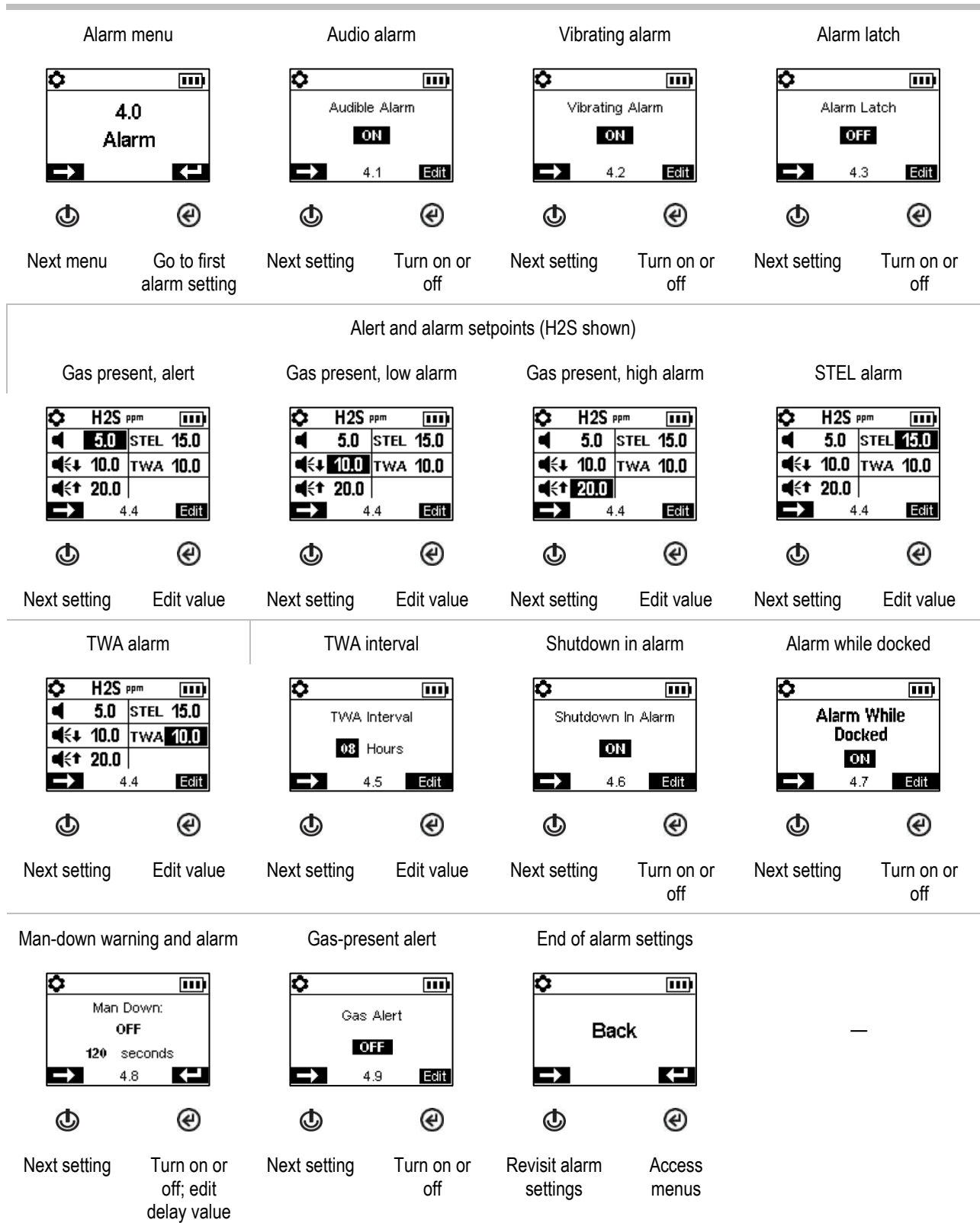

Figure 4.2.D Navigating and editing alarm settings

Sensor menu

Control settings related to calibration and bump testing:

- Choose the "quick" or "independent" process for calibration and bump testing, choose.
 - Quick process.* This process allows for only one application of gas. It is well suited for installed sensor combinations that use a calibration gas cylinder of the "blended" type—one that contains the gas types and concentrations required for *all* installed sensors.
 - Independent process.* This process for more than one application of gas, and the process allows time—between gas applications—for the change of cylinders. It is well suited for installed sensor combinations that require more than one calibration gas cylinders.
- Set calibration gas concentrations for each sensor. For LEL sensors, select the unit of measure, calibration gas type, and correlation factor.

View the location of each installed sensor and its span reserve percentages. *Note:* An indicator of a sensor's remaining life, the span reserve percentage will decline over time; when its value is less than 50%, the sensor will no longer pass calibration.

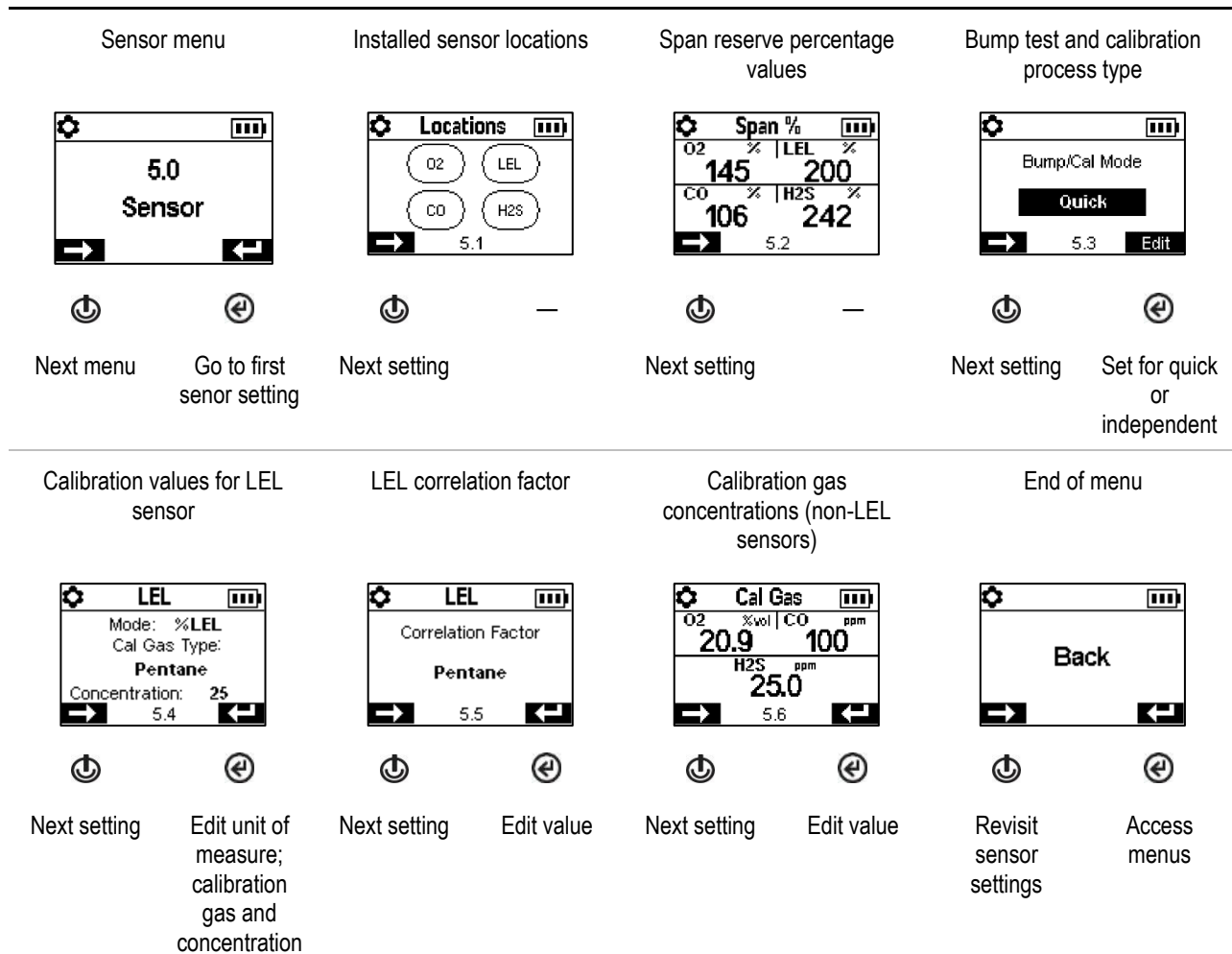

Figure 4.2.E Navigating and editing sensor settings

Admin Menu

Control the ways in which an instrument will interact with its user and set time-based values that are related to the data-log entries and bump testing.

To help protect access to settings, set the instrument's security code value to any three-digit number from 001 to 999. A value of 000 will leave settings *unprotected* and potentially accessible all instrument users.

A security code of 001-999 is also required for the use of always-on functionality; if set to 000, an always-on unit can be powered off without a security code.

Sensors pass a bump test when they sense the specified percentage of calibration gas (or "pass limit") within the specified response-time setting. Set the bump test criteria for these two values:

- a pass limit value from 50 to 99%
- a response-time value from 30 to 120 seconds

Note: For calibration gas recommendations, see "Table 2.5, Sensor specifications".

Turn on or off each of these warnings: scheduled bump test due, scheduled calibration due, and scheduled dock (or "synch") due. For each warning that is set for on, set these two values:

- a warning type of audible only, visual only, or both audible and visual
- the maintenance interval (set in one-day increments for dock and calibration and half-day increments for bump test)

The confidence indicator emits a signal every 90 seconds to indicate to the user and others who are nearby that the instrument is powered on. If the indicator is set for on, choose a warning type of audible only, visual only, or both audible and visual.

Set the instrument's display language.

To support data-log integrity, set the date and time; these values are associated with gas-readings and event data that are saved to the data log.

		Security code	Confidence indicator	Scheduled maintenance warnings	
Next menu	Go to first admin setting	Next setting	Turn on or off; set indicator type	Next setting	Turn on or off

Maintenance intervals

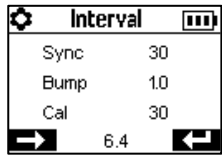

Next setting

Set interval (days)

Bump test criteria

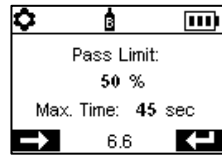

Next setting

Edit percentage and time

Display-screen language

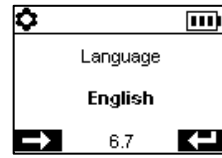

Next setting

Choose display-screen language

Current date

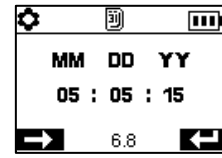

Next setting

Edit values

Current time

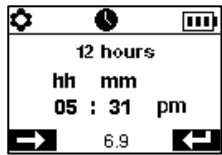

Next setting

Edit values

End of menu

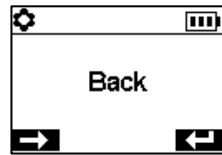

Revisit sensor settings

Access menus

End of setting

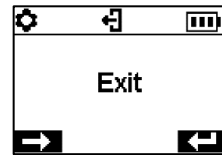

Revisit settings

Exit settings

Figure 4.2.F Navigating and editing admin settings

Operation

The Instrument Buttons

The Instrument Display

Operating the Instrument

Wearing the Instrument

Alarms and Warnings At-a-glance

User-Site Assignments

The Instrument Buttons

Ventis Pro Series instruments have three buttons, the power button, the enter button, and the panic button. During operation, the buttons are used as described below in Figure 5.1

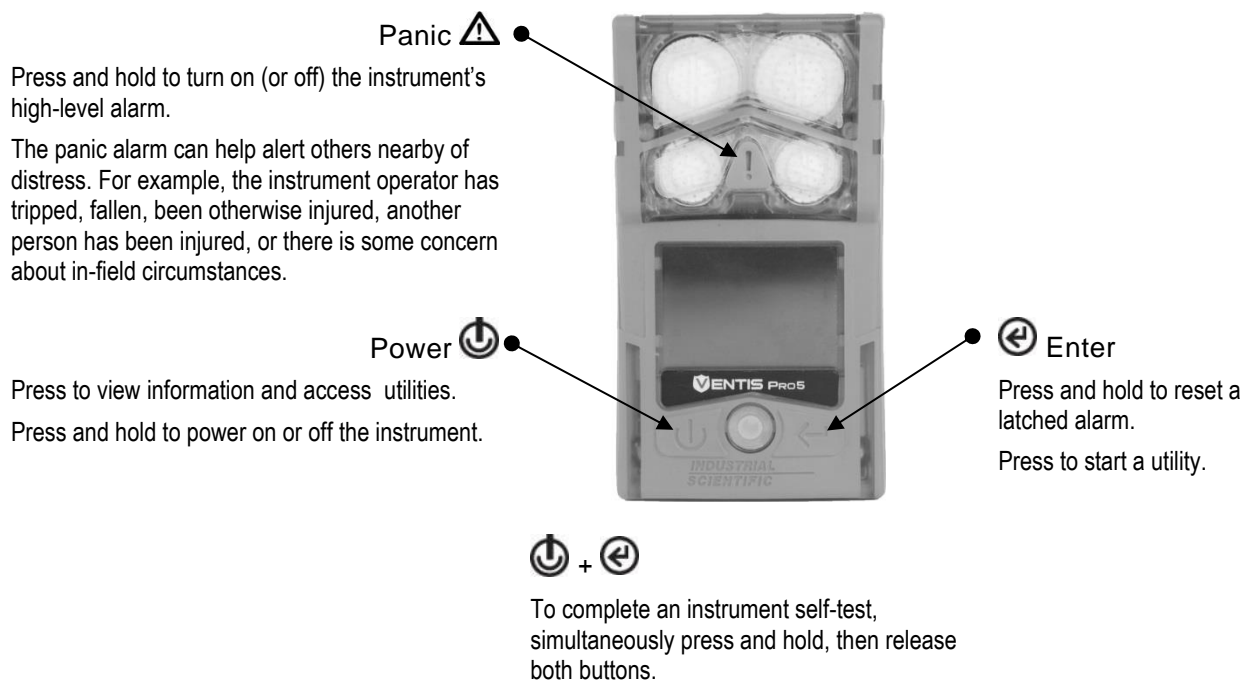

Figure 5.1 Using the buttons during operation

The Instrument Display

After a unit has been powered on—its self-test and start-up sequence successfully completed—the gas readings should display. This display screen is referred to as “Home”, which will generally look like the samples shown below for a five-gas instrument (enlarged for detail) and a four-gas instrument. During operation, the home screen will display unless the instrument is using the screen to provide information about an alarm, warning, indicator, or status item, or the instrument operator has accessed another option.

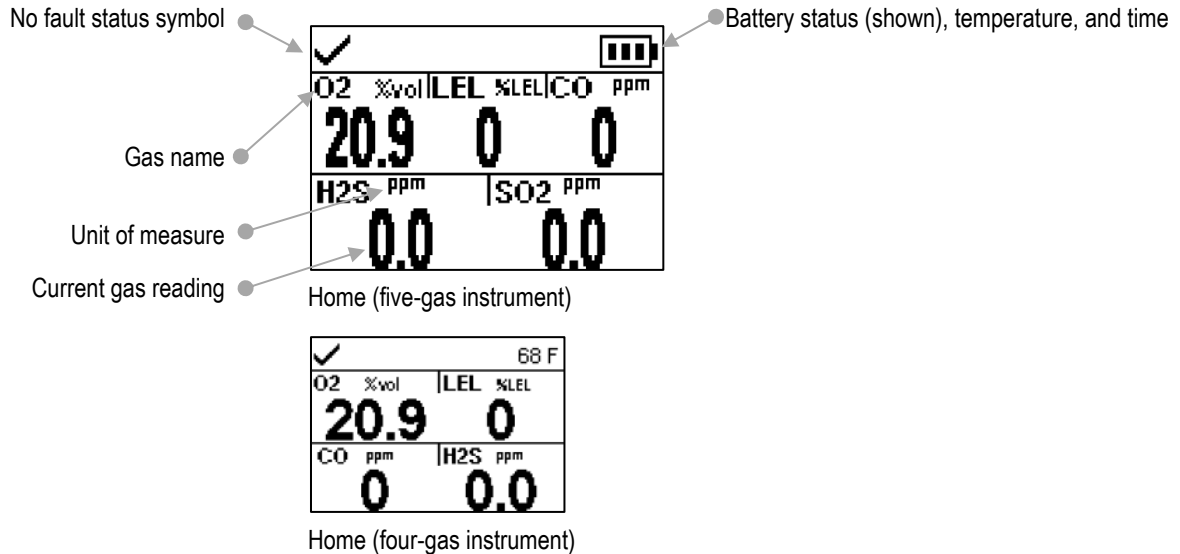

Figure 5.2 Home

Operating the Instrument

From the home screen, a series of display screens may be accessible depending on the unit's settings. Some are information screens and some are utilities.

Information

Information screens display briefly, require no user action, and may include:

- Number of days until the instrument is due to be docked.
- Number of days until the instrument is due for calibration or the number of days since its last calibration.
- Gas settings information (alert and alarm setpoints and calibration gas concentration for the installed sensors).
- Assignment information (the company, use, and site assigned to the instrument).

Utilities

Utilities give the instrument operator opportunities to complete maintenance procedures, which may include:

- Zero the installed sensors and calibrate the instrument.
- Bump test the installed sensors.

- View and optionally clear the peak readings.
- View and optionally clear the TWA readings.
- View and optionally clear the STEL readings.

When a reading is cleared, its value is reset to zero and its time-related setting is also reset to zero.

Figure 5.3 (below) describes and illustrates how to access information and utilities. Available options will vary based on instrument settings. The sample display screens shown here feature 3-, 4-, and 5-gas formats.

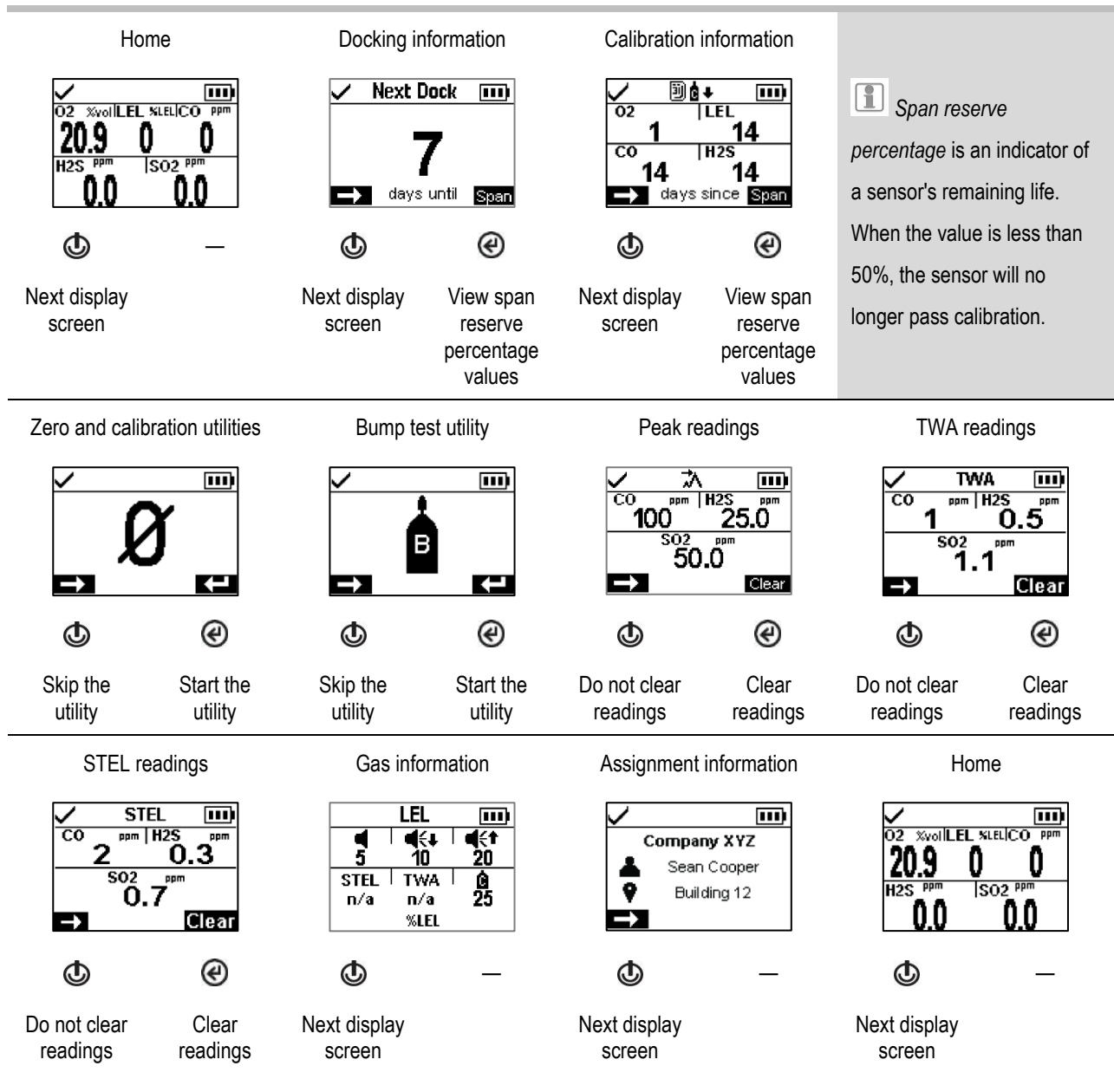

Figure 5.3 Operation instruction

Wearing the Instrument

The instrument may be worn with its factory-installed clip, which is solely intended for attachment to a garment.

As shown below, the clip should be securely fastened and attached in a manner that ensures the instrument's sensor ports are fully exposed to the air. No part of the instrument should be covered by any garment, part of a garment, or other item that would restrict the flow of air to the sensors or impair the operator's access to the audible, visual, or vibration alarms.

Suspender clip



Lift the clip cover.

Position the garment between the clip's upper and lower teeth.

Press down on the clip cover to secure the clip in place.

Alarms and Warnings At-a-glance

Alarms

Alarms notify the instrument operator of danger.

The Ventis Pro Series instruments have alarms of two intensities, high and low. Alarms are persistent. They turn off when the alarm-causing event is no longer detected, unless they are latched. A latched alarm can be turned off by pressing .

When all alarm signals* are on:

- The *high* alarm is bright red in color; it uses two different sounds and a vibration. It is fast-paced.
- The *low* alarm is similar to the high alarm, but includes blue as well as bright red light. It is medium-paced.

*Signals (visual, audible, and vibration) vary based on instrument settings.

Information about gas alarms is presented in different formats on the display screen as shown below for an instrument that is in high alarm caused by the CO sensor's gas reading, which is now at 100 ppm.

Alarms (sample display screens)

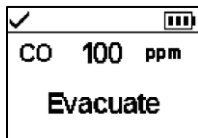

Instruction format
(Evacuate shown)

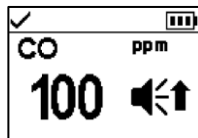

Full screen alarm format

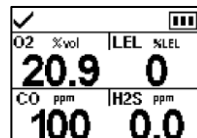

Readings

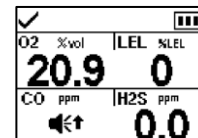

Event type

Display screens shown above indicate that gas is present at the high-alarm level (🔊📶↑). When an alarm is caused by another type of event, the display screens will feature a different symbol as shown below.

High alarm

OR, -OR Gas present (over-range event)

🔊📶↑ Gas present (high-alarm event)

STEL STEL event

ERROR
408 System error

🔋 Critical low battery

⚠️
MAN DOWN Man down

⚠️
PANIC ALARM Panic

Low alarm

🔊📶↓ Gas present (low-alarm event)

TWA TWA event

Warnings

Warnings notify the instrument operator of a condition that needs attention.

Warnings turn on and off repeatedly. The more urgent the warning, the shorter the time between on-off occurrences: a warning that repeats every two seconds is more urgent than a warning that repeats every thirty seconds. Warnings persist until the issue is resolved.

When all signals* are on, a warning appears as a short burst of red and blue light mixed with sound and vibration.

*Signals (visual, audible, and vibration) vary based on instrument settings.

Warnings (sample display screens)

Man-down warning



120-second pre-alarm countdown.

Gas-present alert

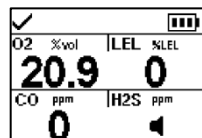

H₂S gas-present alert.

Instrument issue

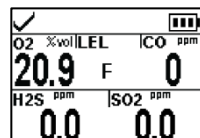

LEL sensor failure.

Maintenance required

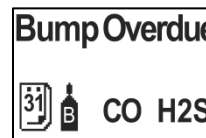

Bump test due for CO and H₂S.

Low battery

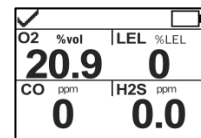

User-site Assignments

iAssign™ tags can be used to change the instrument's user-site assignments. Each tag can contain a user name, site name, or both.

Note: An instrument's settings may or may not permit the use of iAssign technology.

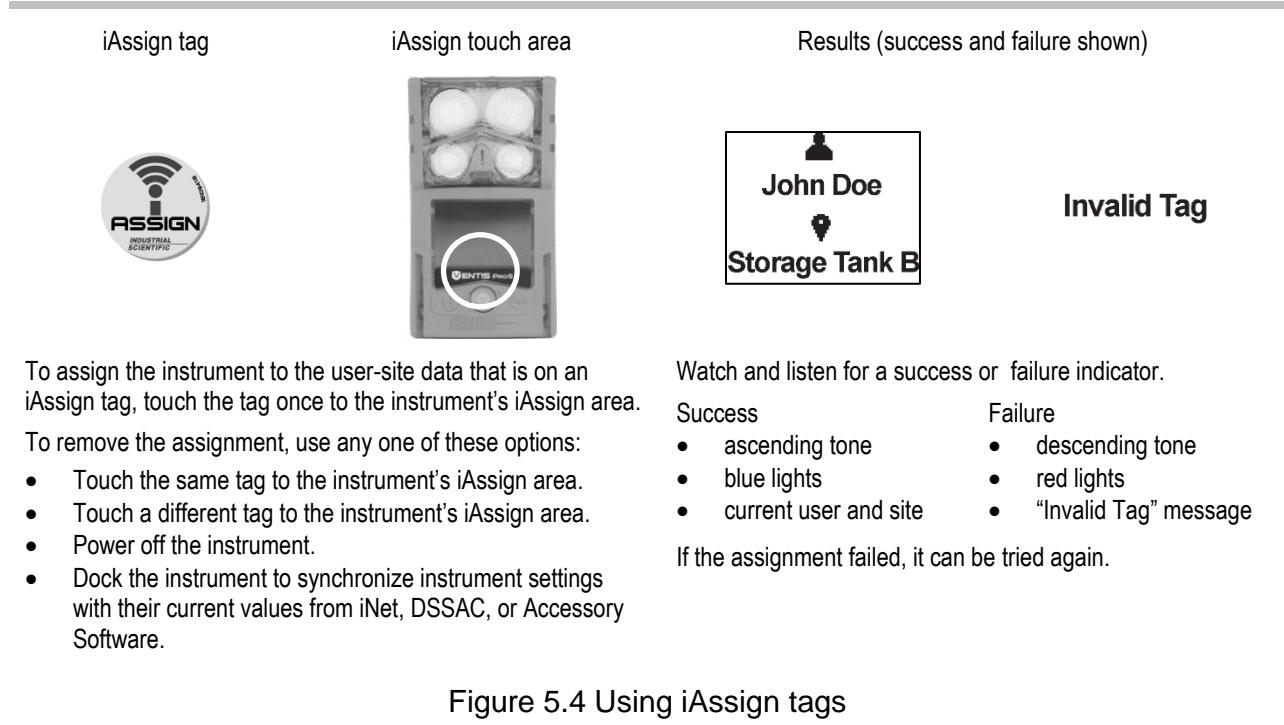

Alarms, Warnings, and Other Notifications

Overview

Alarms

Warnings

Indicators

Failures and Errors

Overview

This chapter provides in-depth information about alarms, warnings, and indicators; portions of this text appear in abbreviated form elsewhere within this product manual.

Alarms notify the instrument operator of danger.

Warnings notify of a condition that needs attention.

Indicators notify of a status (e.g., confidence indicator).

Take seriously all alarms, warnings, and indicators, and respond to each according to company policy.

Alarms

The Ventis Pro Series instruments have alarms of two different intensities, high and low. Alarms are persistent: they turn off when the alarm-causing event is no longer detected; however, if the instrument's alarm latch setting is on, an alarm will remain on until the user presses  to turn it off.

When all alarm signals* are on:

- The *high* alarm is bright red in color; it uses two different sounds and a vibration. It is fast-paced.
- The *low* alarm is similar to the high alarm, but includes blue as well as bright red light. It is medium-paced.

*Signals (visual, audible, and vibration) vary based on instrument settings.

Different events can produce the same alarm. Events are distinguished from one another through the use of symbols (see Table 6.1) that appear on the instrument display screen.

Table 6.1 Alarm events (list)

Alarm symbol	Alarm level	Alarm event	Description
Gas alarms			
	High	Gas present (over-range)	The detected gas concentration is outside the sensor's measuring range.
	High	Gas present (high-alarm)	The detected gas concentration exceeds the high-alarm setpoint.
STEL	High	STEL	The cumulative measure of a detected gas exceeds the STEL setpoint.
	Low	Gas present (low-alarm)	The detected gas concentration exceeds the low-alarm setpoint.
TWA	Low	TWA	The cumulative measure of detected gas exceeds the TWA setpoint.
Nongas alarms			
	High	Man down	The instrument has been stationary for the set period of time. To turn off the alarm, press and hold
	High	Panic	The user has pressed the instrument's panic button and held it long enough (approximately 3 seconds) to turn on the panic alarm. To turn off the alarm, press and hold
ERROR 408	High	System	The instrument is in failure (error code 408 shown here) and is not operational.
	High	Critical low battery	The instrument has shut down and is not operational.

For some alarms, the instrument's display screen provides alarm details in multiple formats, which alternate during the event. For example, a high-alarm gas event has three possible display formats as described and shown below for an instrument that is in high alarm caused by the CO sensor reading, which is now at 100 ppm.

Display screen formats

Instruction

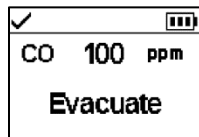

If the instrument is set to provide the user with instruction, the instruction format will be displayed ("Evacuate" shown here); otherwise, the full-screen alarm format will be shown.

Full-screen alarm

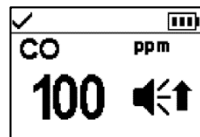

Event

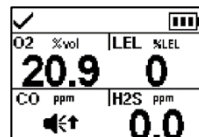

The symbol indicates the event type and identifies the in-alarm sensor.

Current readings are provided for all other installed sensors.

Readings

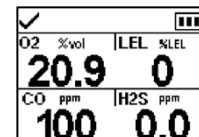

Provides the current reading for the in-alarm sensor and all other installed sensors.

Sample display screens are reproduced below for each event that can cause an alarm. For any event that features multiple display formats, each format is shown here; they will alternate on the display screen during the alarm event.

Alarm level: High

Gas present, over-range alarm

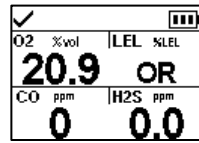
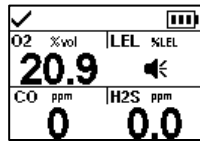
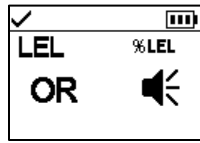

—

Gas present, high alarm

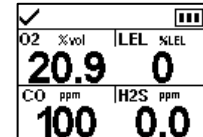
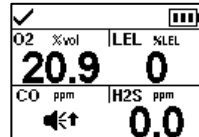
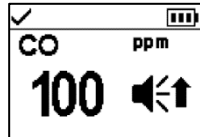
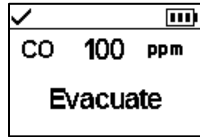

STEL alarm

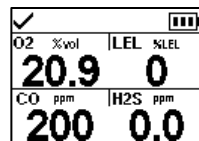
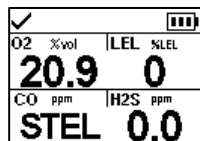
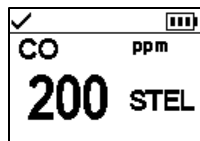

—

Critical low battery alarm

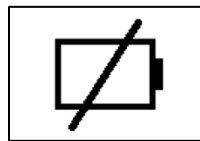

System alarm



Man-down alarm



Panic alarm



Alarm level: Low

Gas present, low alarm

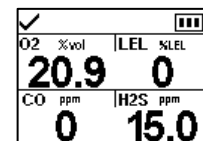
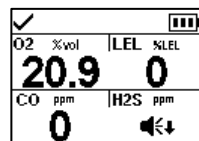
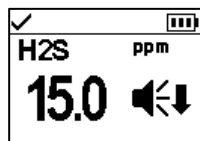
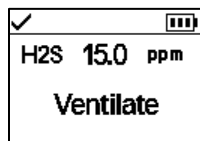

TWA alarm

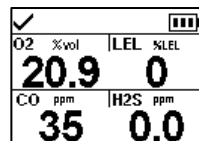
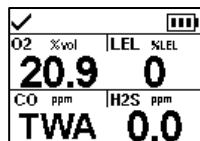
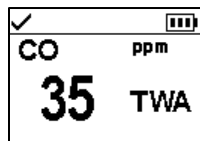

—

Figure 6.1 Alarm events (display screens)

Warnings

Warnings turn on and off repeatedly. The more urgent the warning, the shorter the time between on-off occurrences: a warning that repeats every two seconds is more urgent than a warning that repeats every thirty seconds.







Warnings persist until the event is resolved. In some cases, an unresolved warning will cause an alarm. For example, if the man-down warning turns on and the instrument operator does not turn it off, the instrument and its signals will change from warning status to alarm status. Similarly, a low-battery warning that is not resolved will change to alarm status indicating a critical low-battery condition.

When all signal* settings are on, warnings appear as a short burst of blue and red light mixed with sound and a vibration.

As with alarm events, warning events are distinguished from one another on the instrument display screen (see Table 6.2 below).

*Signals (visual, audible, and vibration) vary based on instrument settings.

Table 6.2 Warning events (list)

Symbol	Warning frequency	Warning event	Description
	Every 2 seconds	Man-down	The instrument has not moved for the set period of time. To turn off the warning, move the instrument.
	Every 8 seconds	Gas alert	A detected gas concentration may be approaching alarm levels. To turn off the warning, press and hold  .
	Every 10 seconds	LEL-Low O ₂	LEL and O ₂ sensors are installed and the concentration of O ₂ is insufficient for LEL sensor functionality.
	Every 15 seconds	Sensor failure	One or more sensors is not working.
	Every 30 seconds	Instrument maintenance required (bump test shown)	The instrument is in need of some form of maintenance (calibration, bump test, etc.).
	Every 60 seconds	Low battery	The instrument's battery is low; replace or charge the battery.

Display-screen reproductions are shown below for each event that can cause a warning. For any event that features multiple display formats, each format is shown; they will alternate on the display screen during the event.

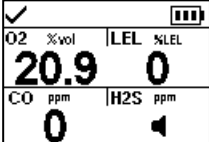
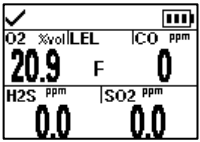
Man-down warning (120 second countdown to alarm shown here)	Gas alert (5.0 ppm H ₂ S shown here)	Sensor failure warning (LEL shown here)
		

Maintenance required warning

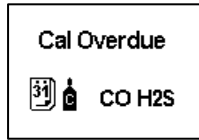

Low battery warning

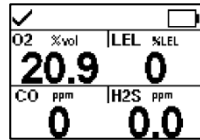

—

Figure 6.2 Warning events (display screens)

Indicators

Most indicators turn on once, then off; only the confidence indicator persists, repeating every 90 seconds. If all signal* settings are on, indicators will look and sound like this:

Indicator	Status	Color	Sound
User or site assignment, calibration, or bump test	Success	Blue	Ascending
User or site assignment, calibration, or bump test	Failure	Red	Descending
Confidence indicator	Instrument on	Blue	Beep

*Signals (visual, audible, and vibration) vary based on instrument settings.

Failures and Errors

Some failures and errors are easily resolved by qualified personnel (see Table 6.3 below). For other errors or failures, contact Industrial Scientific for assistance.

Table 6.3 Failures and errors

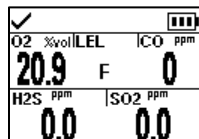

The sample display screen (left) indicates a sensor failure. The position of the “F” means it is the LEL sensor that is in failure. As noted below, different abbreviations or symbols are used to indicate other failures and errors.

Symbols	Cause	Recommended actions
F only	The sensor is in a general state of failure and is not operational.	Power off the instrument, then power it back on. If the failure persists, check the sensor for proper installation.
ERR	The sensor is installed in the wrong location.	Install the sensor in its correct location.
ØF	The sensor failed the zero process.	Repeat the zero process.
BUMP and F	The sensor failed bump testing.	Calibrate the instrument, then complete a bump test.
CAL and F	The sensor failed calibration.	Calibration results indicate the sensor's span reserve percentages. When that value is less than 50%, the sensor will not pass calibration and is due for replacement. If the span reserve percentage indicates the sensor is greater than 50% check for the following possible causes for

Table 6.3 Failures and errors

	<p>! and gas reading</p> <p>A sensor that was operating in DualSense has failed.</p>	<p>the failure.</p> <ul style="list-style-type: none"> • Ensure the calibration cup is compatible with the instrument and is correctly and securely placed on the instrument. • Check the tubing for splits, blockages, or damage. • Ensure the tubing is secured to the calibration cup and the cylinder's regulator. • Ensure the cylinder is not empty and contains the required gas concentrations. <p>If desired, repeat the calibration process.</p> <p>The remaining sensor is operating as a single sensor. Respond according to company safety policy.</p>
--	--	---

When a failure is caused by conditions other than those listed above, an error code will display. Some indicate a possible installation error or compatibility issue; qualified personnel may attempt to resolve these and other errors (see Table 6.4 below). For all other error codes, contact Industrial Scientific for assistance.

Table 6.4 Critical errors

<p>ERROR 408</p>	<p>The display screen reproduction shown here (left) is an example of a critical error. The instrument is put into a state of failure until the error is resolved. The 408 code indicates a specific issue; different codes are used to indicate various failures.</p>																
	<table border="1"> <thead> <tr> <th>Error code</th> <th>Cause</th> <th>Possible resolution</th> </tr> </thead> <tbody> <tr> <td>406</td> <td>A sensor is installed in the wrong location.</td> <td>Check the sensor type and install it in its correct location.</td> </tr> <tr> <td>408</td> <td>No sensors are installed or the installed sensors are not detected by the instrument.</td> <td>Check the installed sensor for proper installation, correct location, and compatibility.</td> </tr> <tr> <td>490</td> <td>A sensor may have become disconnected from the circuit board.</td> <td>Check for a loose or dislodged sensor, and for damage to the sensor pins and their board receptors.</td> </tr> <tr> <td>470</td> <td>An incompatible battery is installed.</td> <td>Check the installed battery's part number for compatibility; install a compatible battery if needed.</td> </tr> </tbody> </table>	Error code	Cause	Possible resolution	406	A sensor is installed in the wrong location.	Check the sensor type and install it in its correct location.	408	No sensors are installed or the installed sensors are not detected by the instrument.	Check the installed sensor for proper installation, correct location, and compatibility.	490	A sensor may have become disconnected from the circuit board.	Check for a loose or dislodged sensor, and for damage to the sensor pins and their board receptors.	470	An incompatible battery is installed.	Check the installed battery's part number for compatibility; install a compatible battery if needed.	
Error code	Cause	Possible resolution															
406	A sensor is installed in the wrong location.	Check the sensor type and install it in its correct location.															
408	No sensors are installed or the installed sensors are not detected by the instrument.	Check the installed sensor for proper installation, correct location, and compatibility.															
490	A sensor may have become disconnected from the circuit board.	Check for a loose or dislodged sensor, and for damage to the sensor pins and their board receptors.															
470	An incompatible battery is installed.	Check the installed battery's part number for compatibility; install a compatible battery if needed.															

Maintenance

Guidelines

Process At-a-glance

Supplies and Preparation

Instruction

Guidelines

This chapter provides instruction for manually completing these utilities: bump testing, zeroing, and calibration. These procedures can also be completed using compatible Industrial Scientific docking stations and accessories that are supported by iNet, DSSAC, or Accessory Software. Elsewhere in this product manual (Chapter 1), are the definitions and recommended practices for each procedure.

Use these guidelines to prepare for manually completing a zero, calibration, or bump test.

- Work in an area known to be nonhazardous.
- Use certified Industrial Scientific calibration gas.
- Choose calibration gas cylinders that are suitable for the installed sensors and their calibration gas settings, and for the instrument's process-type setting ("quick" vs. "independent").

When instruments are set to the "quick" process type, one application of gas is permitted. This setting is usually the choice for applications in which one calibration gas cylinder contains all the required gases.

When set to the "independent" process type (a.k.a., "standard" process), it is often because more than one gas cylinder is required to calibrate or bump test all the installed sensor types. For example, a cylinder that contains more than one gas may be suitable for three of the installed sensors while the fourth sensor may require a gas that is not contained in that cylinder. During the independent process, the instrument will prompt its user for the application of each gas and, between gases, will allow time for a change of cylinders.

Process At-a-glance

Whether bump testing or calibrating manually, the basic steps are:

- Gather the needed supplies.
- Prepare the gas cylinder for use.
- Access the utility on the instrument.
- Connect the calibration cup to the instrument.

- Turn on the gas cylinder.
- View the results.
- Remove the calibration cup.
- *Turn off the gas cylinder.*

Supplies and Preparation

Use Figure 7.1 as a guide to gathering supplies and preparing the calibration gas cylinders.

Supplies

- Calibration gas cylinder or cylinders
 - Positive flow regulator suitable for the calibration gas cylinders
 - Calibration cup (shipped with the instrument)
 - Calibration tubing (shipped with the instrument)
-

Preparation



Holding the regulator, turn the calibration gas cylinder in a clockwise direction to tighten.

If a change in cylinders will be needed for an independent calibration or bump test, this preparation step can be completed for each cylinder.



Connect either end of the calibration tubing to the regulator's nipple.



Connect the other end of the tubing to the calibration cup.

Figure 7.1 Maintenance supplies and preparation

Instruction

Figure 7.2.A through 7.2.C provide maintenance instruction in this order: zeroing, calibration, and bump testing. The independent process is shown for calibration and the quick process is shown for bump testing.

Zeroing







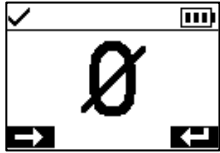
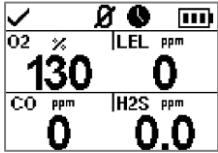
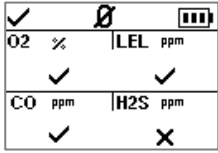

Zero utility	Zero Progress	Zero Results
		
 	 	 Passed  Failed
Cancel Start zero process		If any sensor failed, press  to access the zero utility and repeat the zero process.

Figure 7.2.A Zeroing instruction







Calibration (independent process shown)



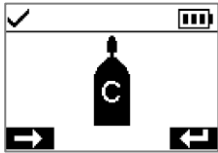
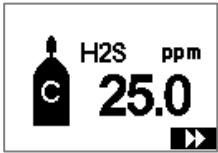

Place the prepared calibration cup over the instrument case top.
Press down to secure the cup in place; a click will sound.



Visually inspect the calibration cup to ensure its edges along the top and sides align with the instrument case top edges.

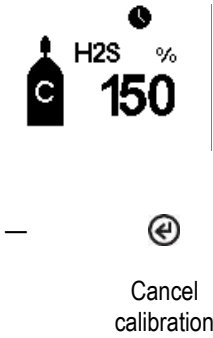

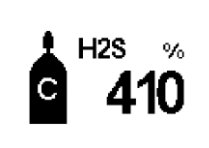

Calibration utility	Calibration apply gas	
		
 	 	
Cancel calibration	Start calibration	If desired, skip calibration for the displayed gas

Calibration progress	Calibration results	
	<p>When the calibration is completed, the instrument will display a calibration results of passed or failed, along with the sensor's span reserve percentage.</p>	<div style="display: flex; justify-content: space-around;"> <div data-bbox="841 268 1057 415">  </div> <div data-bbox="1170 268 1386 415">  </div> </div>
<p>—  Cancel calibration</p>	<p>✓ Passed ✗ Failed</p>	<p>The span reserve percentage is an indicator of the sensor's remaining life. When that value is less than 50%, the sensor will no longer pass calibration.</p>

After the first sensor is calibrated and the results displayed, the instrument will activate the calibration process for the next gas type starting with the "Apply gas" request. The instrument will wait a few minutes to receive the requested calibration gas. This is the opportunity to change cylinders if needed, then continue the calibration process (in the same manner as described above for H₂S) until all calibration gases have been applied.

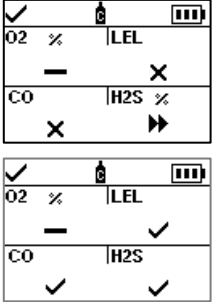
After the installed sensors have been calibrated (or skipped), the instrument's display screen will state the calibration results for all installed sensors.

All-sensor calibration results	End	
<p>✓ Passed ✗ Failed ▶▶ Skipped — Not relevant to the procedure.</p>		<div style="display: flex; justify-content: space-around;"> <div data-bbox="797 1018 1089 1207">  <p>Remove the calibration cup: lift up from the cup's tabs.</p> </div> <div data-bbox="1128 1018 1421 1207">  <p>Stop the flow of gas: turn the regulator knob in a clockwise direction and tighten.</p> </div> </div>

 Use Table 7.1 as a guide to help determine the probable cause for calibration failure and find recommendations for resolution.

Figure 7.2.B Calibration instruction

Bump testing (quick process shown)

Place the prepared calibration cup over the instrument case top.

Press down to secure the cup in place; a click will sound.



Visually inspect the calibration cup to ensure its edges along the top and sides align with the instrument case top edges.



Bump test utility

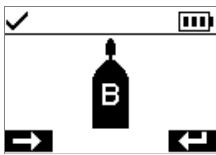

Cancel bump test



Start bump test

Apply gas

✓	🔋	🕒	🔋
O ₂ %vol	LEL %LEL		
20.9	25		
C-O ppm	H ₂ S ppm		
100	25.0		



Apply calibration gases of the type and concentration stated on the instrument's display screen: turn the cylinder's regulator knob in a counterclockwise direction.

Bump test progress

✓	🔋	🕒	🔋
C-O ppm	H ₂ S ppm		
100	25.0		
LEL %LEL	O ₂		
10.0	—		



Cancel bump test

All-sensor bump test results

✓	🔋	🕒	🔋
O ₂	LEL		
✓	✓		
C-O	H ₂ S		
✓	✓		

After the bump test is completed, summary results are shown.

If any sensors fail the bump test, the calibration required warning will turn on. Complete a calibration for any failed sensor, then repeat the bump test.

- ✓ Passed
- ✗ Failed
- ▶▶ Skipped
- Not relevant to the procedure

✓	🔋	🕒	🔋
O ₂ ppm	LEL ppm		
✗	✗		
C-O ppm	H ₂ S ppm		
✗	✗		

End



Remove the calibration cup: lift up from the cup's tabs.



Stop the flow of gas: turn the regulator knob in a clockwise direction and tighten.

Figure 7.2.C Bump testing instruction

Table 7.1 Calibration failure: possible causes and recommendations

Possible causes for calibration failure	Recommendations
The sensor's span reserve percentage is less than 50%.	The sensor is due for replacement.
The gas cylinder did not contain the calibration gas in the concentration needed.	Repeat the calibration with a suitable gas cylinder.
When all sensors fail, this may indicate the calibration gas did not reach the sensors.	Check for the following. <ul style="list-style-type: none">• Ensure the calibration cup is compatible with the instrument.• Ensure the calibration cup is correctly and securely placed on the instrument.• Check the tubing for splits, blockages, or damage.• Ensure the tubing is secured to the calibration cup and the cylinder's regulator.• Ensure the cylinder is not empty and contains the required gas concentrations.• Be sure the cylinder is turned on when the apply-gas screen displays and remains on until the calibration is completed. Repeat the calibration.

Service and Warranty

Service

Warranty

Service

Guidelines

Service tasks that can be completed by Industrial Scientific customers are described in this Product Manual. Table 8.1 indicates which parts and components are customer replaceable. All other service tasks should be performed only by Industrial Scientific or an authorized service center.

- Service tasks should be performed only by qualified personnel.
- Use only approved Industrial Scientific parts and accessories.
- Perform service tasks in a nonhazardous location.
- Work on a nonconductive surface in a well-lit area.
- Wear grounding straps to prevent electrostatic discharge (ESD), which can cause damage to the instrument's electronics.
- Before removing the instrument's battery, dock the instrument to synchronize it with iNet Control, Accessory Software, or DSSAC.

Use care when working with the adhesive-backed filters and gaskets.

- Be careful not to pierce or tear these items.
- When using tweezers, apply gentle pressure.
- Once the adhesive touches a surface, any attempt to remove or reposition the item may cause it damage.

Use care when working with sensors and water barriers.

- Do not touch the sensors' white membranes as this can contaminate the sensors.
- Do not separate the sensor from its membrane.
- Do not damage or tear the membranes or water barriers.

Supplies

- ✓ T10 torx screwdriver
- ✓ Needle-nose tweezers (for barrier and filter replacement)

Instruction

Figures 8.1 and 8.2 provide disassembled views of the instrument and its pump module, respectively, identifying their parts and components. Use Table 8.1 to determine which items are customer replaceable and identify their part names and part numbers.

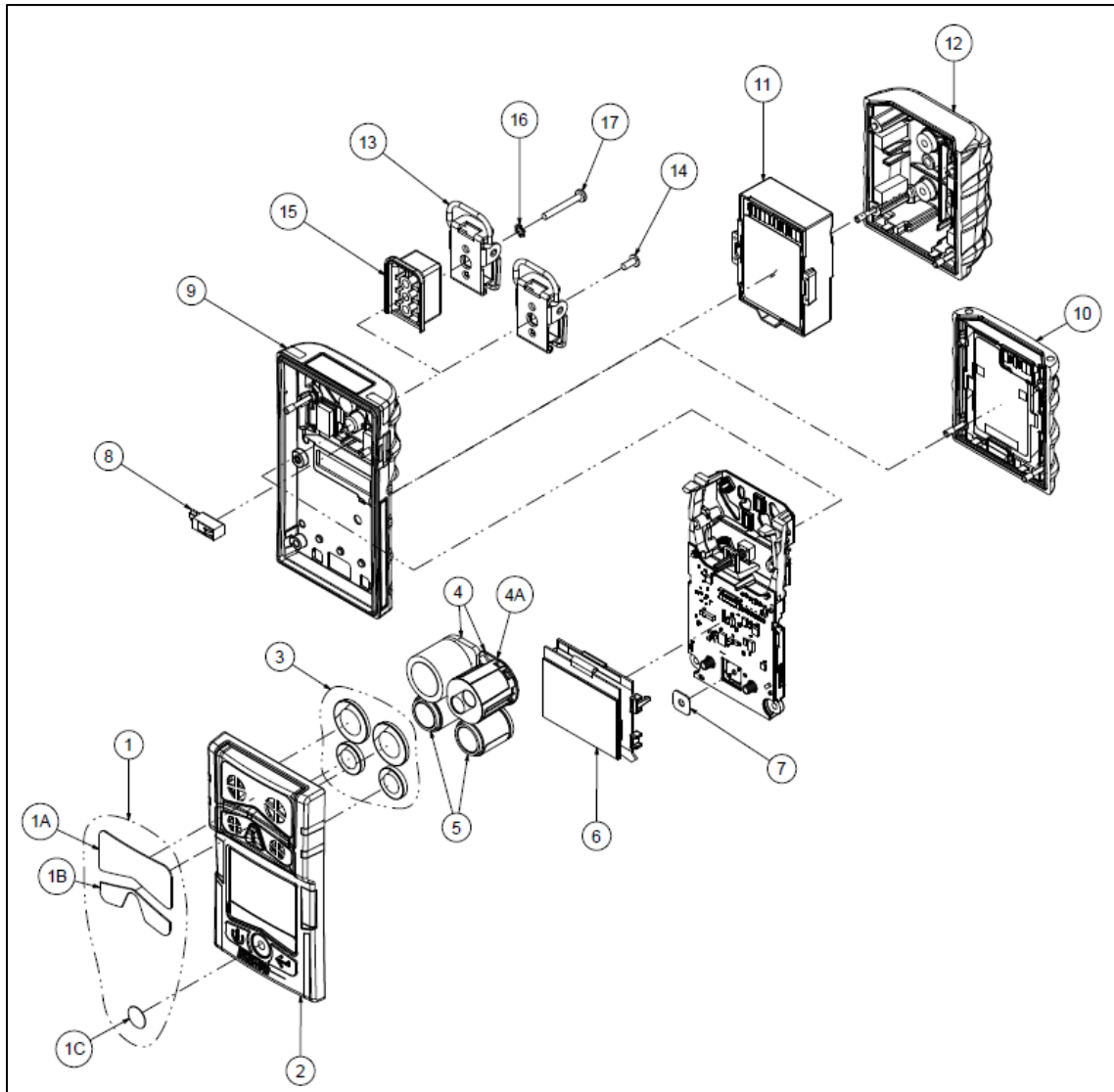

Figure 8.1 Instrument diagram

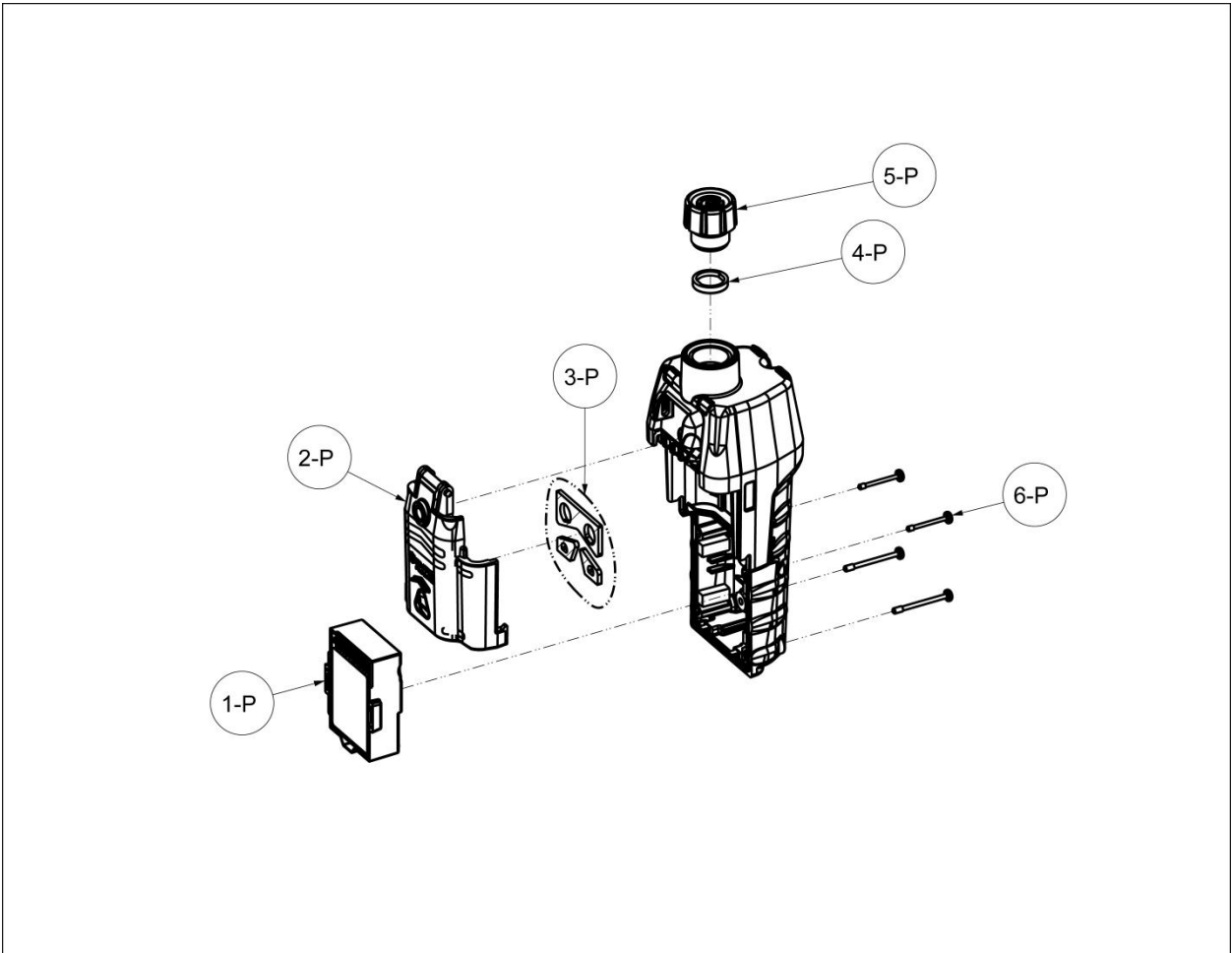

Figure 8.2 Pump module diagram

Table 8.1 Instrument and pump module parts list

Diagram number	Part name	Customer replaceable	Part number	Notes
Instrument				
1 (includes 1A, 1B, and 1C)	Dust barrier kit	Yes	18109435	Includes ten of each sensor dust barrier and ten speaker dust barriers.
2 (includes 1A, 1B, 1C, and 3)	Case top assembly	Yes	17156049-XY	Assembly includes case top, dust barriers, and water barriers X indicates case-cover color, where 0 = Black and 1 = Orange. Y indicates name plate, where 1 = Ventis Pro4 and 2 = Ventis Pro5.

Table 8.1 Instrument and pump module parts list

Diagram number	Part name	Customer replaceable	Part number	Notes
3	Sensor water barrier kit	Yes	18109436	Includes one water barrier for each sensor port.
4, 4a, and 5				See "Table 2.5 Sensor specifications" for details about sensor compatibility and permitted installation locations.
	Ammonia (NH ₃)	Yes	17155306-6	Ventis Pro5 only.
	Carbon Dioxide/Hydrocarbons (CO ₂ /HC)	Yes	17155304-U	Ventis Pro5 only.
	Carbon Dioxide/Methane (CO ₂ /CH ₄)	Yes	17155304-V	Ventis Pro5 only.
	Carbon Monoxide (CO)	Yes	17155306-1	
	Carbon Monoxide/Hydrogen Sulfide (CO/H ₂ S)	Yes	17155304-J	Ventis Pro5 only.
	Carbon Monoxide/Hydrogen Sulfide (CO/H ₂ S)	Yes	17155306-J	Ventis Pro5 only.
	Carbon Monoxide with low Hydrogen cross-sensitivity (CO/H ₂ Low)	Yes	17155306-G	—
	Hydrogen Cyanide (HCN)	Yes	17155306-B	—
	Hydrogen Sulfide (H ₂ S)	Yes	17155306-2	—
	Hydrogen Sulfide (H ₂ S)	Yes	17155304-2	—
	LEL (Methane)	Yes	17155304-L	—
	LEL (Pentane)	Yes	17155304-K	—
	Methane, 0-5% vol.	Yes	17155304-M	—
	Nitrogen Dioxide (NO ₂)	Yes	17155306-4	—
	Oxygen (O ₂)	Yes	17155304-3	—
	Sulfur Dioxide (SO ₂)	Yes	17155306-5	—
6	LCD assembly	No*	—	—
7	Audible alarm speaker	No*	—	—
8	Vibration alarm motor	Yes	17120080	—
9	Case bottom	No*	—	Torque: .39 newton m (55 ounce-force inch)
10	Rechargeable lithium-ion battery pack	Yes	17134453-0Y	Y indicates approvals where 1 = UL, ATEX, and IECEx. Torque: 0.39 newton m (55 ounce-force inch)

Table 8.1 Instrument and pump module parts list

Diagram number	Part name	Customer replaceable	Part number	Notes
11	Extended-run-time, rechargeable lithium-ion battery	Yes	17148313-Y	Y indicates approvals where 1 = UL, ATEX, and IECEx. Torque: 0.39 newton m (55 ounce-force inch)
12	Battery cover (for use with extended-run-time, rechargeable lithium-ion battery)	Yes	17151184-0Y	Y indicates approvals where 1 = UL, ATEX, and IECEx. Torque: 0.39 newton m (55 ounce-force inch)
13	Suspender clip	Yes	17120528	—
14	Screw with locking washer	Yes	17139262	Torque: .81 newton m (115 ounce-force inch)
15	Suspender clip spacer	Yes	17152506	—
16	Locking washer	Yes	17153137	—
17	Screw (for use with suspender clip spacer)	Yes	17152507	Torque: .81 newton m (115 ounce-force inch)
Pump				
1P - 6P	Pump module	Yes	VPP-ABCD	A indicates battery, where 0 = no battery and 2 = extended-run-time rechargeable lithium-ion battery B indicates color, where 0 = black and 1 = orange C indicates approvals, where 1=UL and CSA, 2 = ATEX and IECEx. , D indicates language, where 1 = English, 2 = French, 3 = Spanish, and 4 = German
Pump module parts				
1P	Extended-run-time, rechargeable lithium-ion battery	Yes	17148313-Y	Y indicates approvals where 1 = UL, ATEX, and IECEx. Torque: 0.39 newton m (55 ounce-force inch)
2P (includes 3P)	Door assembly	Yes	17156945-X	X indicates color, where 0 = black and 1 = orange.
3P	Gaskets	No*	—	—
4P	Inlet water barrier	Yes	17152395	—
5P	Inlet cap	Yes	17129909	—

*For items that are *not* customer replaceable, contact Industrial Scientific or an authorized service center.



Power off the instrument before disassembling it or performing any service task.

Pump installation



Unscrew and remove the belt clip. Store the clip, screw, and washer for future use.



Unscrew, lift, and remove the battery pack from the diffusion instrument; store it for future use.

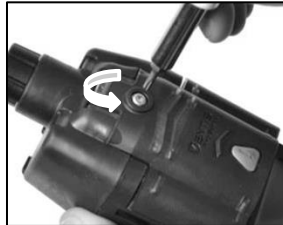

Loosen the pump door screw.

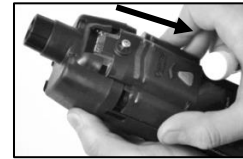

Slide the pump door down; lift it to open.

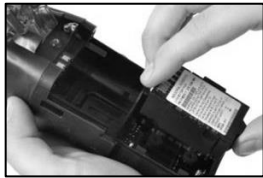

Install a compatible extended-run-time battery—label side up—into the lower receptacle of the pump case.



Place the instrument in the pump case.



Lower the pump door. Slide it into its fully closed, clicked-shut position.



Tighten the pump door screw.

Pump door replacement



Loosen the pump door screw.
Slide the pump door down; lift it to open.

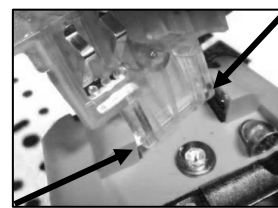

The door is hinged to the pump module with two pegs that slide into grooves. Angle the door so that one peg moves to the bottom of its groove and the other moves the top of its groove. Lift the door to remove it.

Install the new door in the same manner the door was removed.



Lower the pump door. Slide it into its fully closed, clicked-shut position. Tighten the pump door screw.

Pump cap and water barrier replacement



To unscrew and remove the pump cap, turn it in a counterclockwise direction.



Remove the water barrier from the inlet barrel.



Place the new water barrier inside the inlet barrel; the side with the larger filter surface should face the user.



Secure the pump cap to the inlet barrel: turn it in a clockwise direction to tighten.

Battery replacement



Using a torx screwdriver, loosen all four screws from the battery pack (left) or the battery cover (right).



Lift the battery pack (left) or battery cover and extended-run-time battery (right) away from the instrument.



Note: If the instrument is without a battery for more than 40 minutes, the instrument date and time settings will be deleted. The next time the instrument is powered on, it will prompt its operator to set the date and time to support data-log integrity; this can be done manually or by docking the instrument.



To install the extended-run-time battery, first place the battery in the battery cover. When placed correctly, the battery's label will show.

Next, align the battery cover with the instrument.



To install the battery pack, align it with the instrument.



Using a torx screwdriver, tighten each of the four screws to secure the battery pack (shown) or battery cover to the instrument.

Refer to Table 8.1 for torque value.

Clip replacement

Clip only (use with battery pack)



Lift the clip's cover.

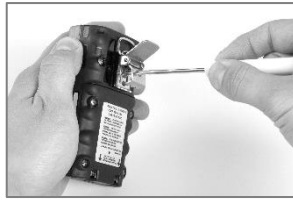

To remove the clip, use a torx screwdriver to access the clip's screw. Turn counterclockwise to loosen the screw.

Remove the screw, washer, and clip; set aside or store for future use.



To attach the clip, put the washer onto the screw and place the screw in the clip's middle hole.

Turn the screw clockwise to tighten; refer to Table 8.1 for torque value.

Clip with spacer (use with extended-run-time battery and battery cover)



To remove the clip, use a torx screwdriver to access the clip's screw. Turn counterclockwise to loosen the screw.

Remove the washer, screw, clip, and spacer; set aside or store for future use.



To attach the clip and spacer, cover the case bottom's platform with the spacer.

Put the washer onto the screw and place the screw in the clip's middle hole.

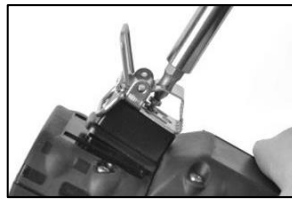

Guide the screw into the spacer's hole and into the instrument case bottom..

Turn clockwise to tighten; refer to Table 8.1 for torque value.

Dust barrier replacement (sensor port dust-barrier shown)



Using a finger or needle-nose tweezers, peel off the dust barrier and discard.

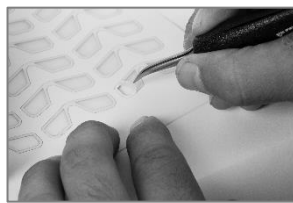

Place the barrier sheet on the work surface.

Scrape lightly across the paper to the barrier's edge. Gently lift to expose a portion of its adhesive back. Peel the barrier from the sheet.



Guide the new barrier— adhesive side down—onto the case top.

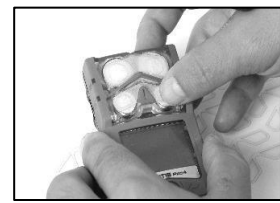

Press and hold to support adhesion.

Instrument disassembly

Instrument disassembly and reassembly is required for the service tasks described below, sensor water barrier replacement and sensor replacement.

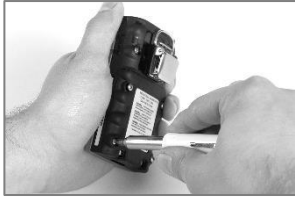

Using a torx screwdriver, loosen all four captive screws on the battery pack.



Lift the battery pack away from the instrument.



Using a torx screwdriver, loosen the case bottom's remaining two screws.

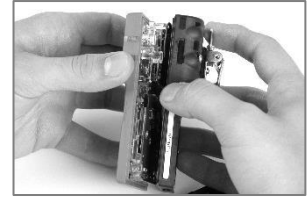

Hold the case bottom near the upper screws. Lift the case top slightly to separate it from the case bottom.



Continue to lift the case top straight up to remove it.



Near the top of the circuit board assembly, hold the plastic sides that border the sensors.

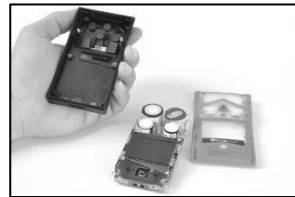

Gently lift the circuit board assembly straight up and away to separate it from the case top.

Sensor water-barrier replacement



Inside the case top, grip the sensor water barrier with the needle-nose tweezers. Peel to remove.

Remove any remnants of the adhesive or water barrier.

Clear away any dirt, dust, or debris.

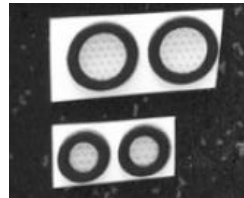

Place the water-barrier sheets on the work surface.

Using the tweezers, scrape lightly across the paper to the barrier's edge; gently lift to expose a portion of the adhesive back.

Grip the barrier lightly with the tweezers and peel it from the packet.



Guide the new water barrier—adhesive side down—into the case top.

For proper placement, take care to ensure the barrier edge meets the inner edge of the case top's sensor opening.

Using care not to touch the filter's white membrane, press on the filter edge to support adhesion.

Sensor replacement (LEL sensor shown)

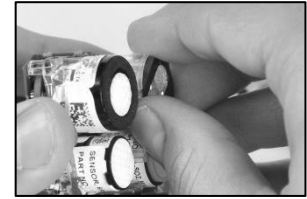
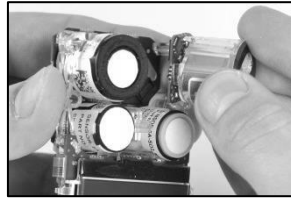
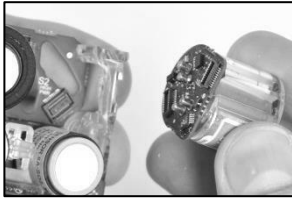

Hold the sides of the sensor firmly then pull it straight up and away from the instrument.

Some sensors, such as the LEL sensor shown here, include a small circuit board that should detach from the instrument board when the sensor is removed. If it does not detach, remove the sensor's board from the instrument board.

Store the sensor for future use or dispose of it according to company policy.

Note: When two sensors of the same type are operating on DualSense, replace both sensors at the same time.

Position the new sensor to align its connectors with their receptacles on the instrument's circuit board assembly.

Secure the sensor in place by applying gentle pressure to the sides of the sensor case. *Do not touch the sensor's membrane.*

A slight connection impact can be felt when the sensor is secured into place.

Note: After reassembling the instrument, calibrate for any newly installed sensors.

Instrument assembly

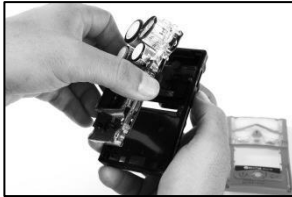

Near the top of circuit board assembly, hold the plastic sides that border the sensors.

Place the circuit board assembly into the instrument's case bottom.

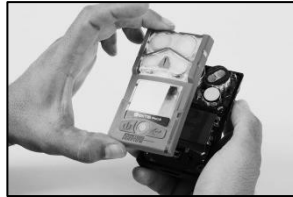

Lower the case top assembly onto the case bottom.



Press to secure the case top to the case bottom.



Using a torx screwdriver, tighten the top two screws. See Table 8.1 for torque value.



Place the battery pack against the case bottom.



Using a torx screwdriver, tighten the screws. See Table 8.1 for torque value.

Figure 8.3 Service Tasks

Warranty

Industrial Scientific Corporation's Ventis™ Pro Series portable gas monitors are warranted to be free from defects in material and workmanship under normal and proper use and service for as long as the instrument is supported by Industrial Scientific.

The above warranty does not include sensors, battery packs, and internal pumps, which are warranted to be free from defects in material and workmanship for 24 months from date of shipment, except where otherwise stated in writing in Industrial Scientific literature accompanying the product.

Limitation of Liability

THE WARRANTY SET FORTH ABOVE IS STRICTLY LIMITED TO ITS TERMS AND IS IN LIEU OF ALL OTHER WARRANTIES, GUARANTEES, EXPRESS OR IMPLIED, ARISING BY OPERATION OF LAW, COURSE OF DEALING, USAGE OF TRADE OR OTHERWISE. INDUSTRIAL SCIENTIFIC MAKES NO OTHER WARRANTIES, EITHER EXPRESSED OR IMPLIED, INCLUDING BUT NOT LIMITED TO THE WARRANTIES OF MERCHANTABILITY OR FITNESS FOR PARTICULAR PURPOSE.

SHOULD THE PRODUCT FAIL TO CONFORM TO THE ABOVE WARRANTY, BUYER'S ONLY REMEDY AND INDUSTRIAL SCIENTIFIC'S ONLY OBLIGATION SHALL BE, AT INDUSTRIAL SCIENTIFIC'S SOLE OPTION, REPLACEMENT OR REPAIR OF SUCH NON-CONFORMING GOODS OR REFUND OF THE ORIGINAL PURCHASE PRICE OF THE NONCONFORMING GOODS.

IN NO EVENT WILL INDUSTRIAL SCIENTIFIC BE LIABLE FOR ANY OTHER SPECIAL, INCIDENTAL, CONSEQUENTIAL, PUNITIVE OR OTHER SIMILAR DAMAGES, INCLUDING LOSS OF PROFIT OR LOSS OF USE, ARISING OUT OF THE SALE, MANUFACTURE OR USE OF ANY PRODUCTS SOLD HEREUNDER WHETHER SUCH CLAIM IS PLEADED IN CONTRACT OR IN TORT, INCLUDING STRICT LIABILITY IN TORT AND WHETHER INDUSTRIAL SCIENTIFIC HAS BEEN ADVISED OF THE POTENTIAL FOR SUCH DAMAGES. Industrial Scientific's total liability hereunder from any cause whatsoever (except liability from personal injury caused by Industrial Scientific's negligence), whether arising under contract, warranty, tort (including negligence), strict liability, products liability or any other theory of liability, will be limited to the lesser of Buyer's actual damages or the price paid to Industrial Scientific for the Products that are the subject of Buyer's claim. All claims against Industrial Scientific must be brought within one year after the cause of action arises, and Buyer expressly waives any longer statute of limitations.

It shall be an express condition to Industrial Scientific's warranty that all products be carefully inspected for damage by Buyer upon receipt, be properly calibrated for Buyer's particular use, and be used, repaired, and maintained in strict accordance with the instructions set forth in Industrial Scientific's product literature. Repair or maintenance by non-qualified personnel will invalidate the warranty, as will the use of non-approved consumables or spare parts. As with any other sophisticated product, it is essential and a condition of Industrial Scientific's warranty that all personnel using the products be fully acquainted with their use, capabilities and limitations as set forth in the applicable product literature.

Buyer acknowledges that it alone has determined the intended purpose and suitability of the goods purchased. It is expressly agreed by the parties that any technical or other advice given by Industrial Scientific with respect to the use of the goods or services is given without charge and at Buyer's risk; therefore, Industrial Scientific assumes no obligations or liability for the advice given or results obtained.

Assignments

Introduction

iAssign Overview

Procedures

Introduction

When user and site names are assigned to Ventis Pro Series instruments, the information is saved in the instrument data log. Assignment data can provide valuable insight into exposure data and user behavior, while being useful when managing assets and investigating potential issues. Instrument assignments can be made using iNet or DSSAC, with Accessory Software, through instrument settings, and with iAssign.

How the assignment is made determines the assignment type. Ventis Pro Series instruments support two assignment types—recurring and temporary.

- A *recurring* assignment is an assignment made using iNet Control, DSSAC, or Accessory Software. Recurring assignments stay with the instrument when the instrument is restarted.
- A *temporary* assignment is an assignment that is made via iAssign or through the instrument settings. Temporary assignments overwrite recurring assignments and stay with the instrument until it is restarted. Upon restart, an instrument with a temporary assignment will revert to the recurring assignment, if one is available. If there is no recurring assignment, the instrument will be unassigned.

See Chapter 4, "Settings" for information about assigning a temporary user or site using the instrument.

iAssign Overview

iAssign technology is used to quickly connect user and site assignments to Ventis Pro Series instruments. It has three components – a smart device application, an iAssign tag, and technology that is built into the instrument. iAssign uses Near Field Communication (NFC) to move user and site data wirelessly when two enabled devices are held close together.



There are two basic steps required to use iAssign:

1. iAssign tags are programmed with an assignment using the iAssign application. The tags can then be distributed to instrument operators or installed at a location.
2. Instrument users touch a Ventis Pro Series instrument to an iAssign tag.

Sample scenario 1: Each employee receives his or her own iAssign tag which can be attached to a name badge, employee ID, or other personal item. Then, each day, the employee picks up an instrument from the shared pool at the start of his or her shift. The instrument is touched to the iAssign tag and the assignment is complete.

Sample scenario 2: The iAssign app can be used to assign the location "Tank 1" to an iAssign tag. The tag can then be installed at the entrance to Tank 1. When Ventis Pro Series instrument operators enter Tank 1, they can touch their instruments to the tag and the location assignment will be saved to the instrument.

The iAssign application can be installed on Android devices by going to www.indsci.com.

Procedures

The first screen that displays when the iAssign application is launched is its home screen. The home screen provides access to read, write, or view tag purchasing information. It also provides access to write tags through a batch process. To return to the home screen at any time, tap the menu button in the title bar.

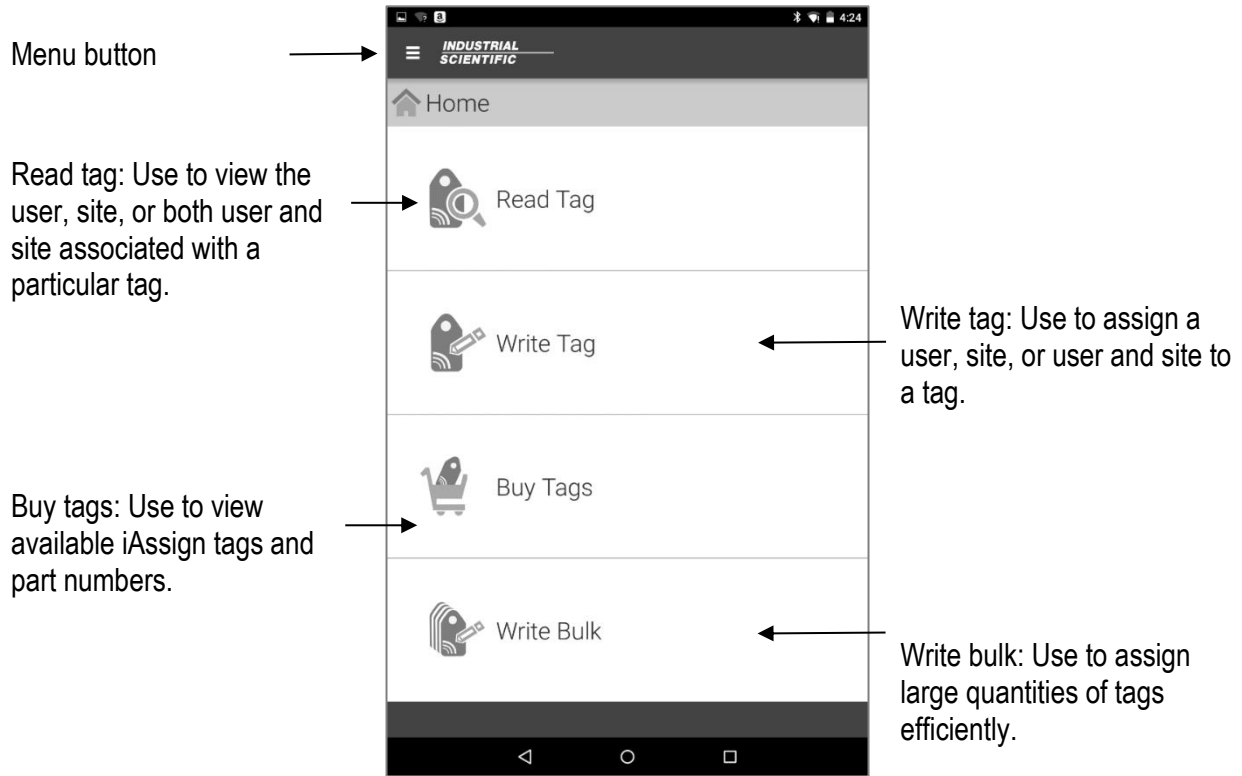
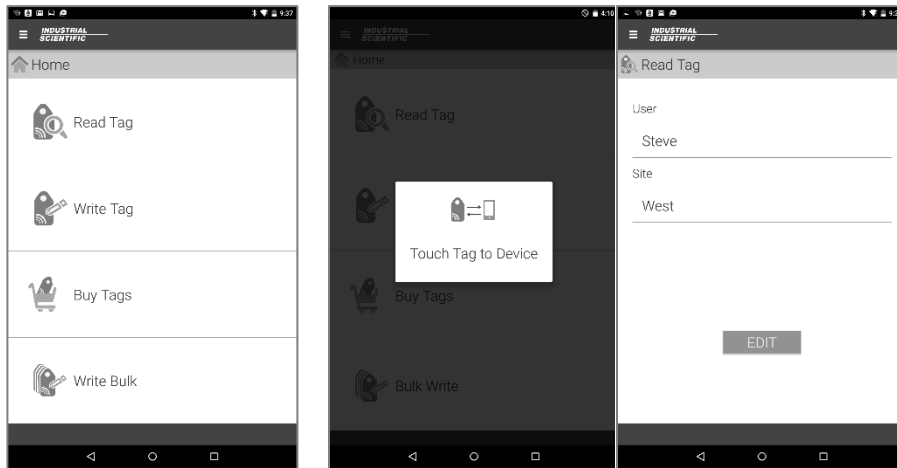

Table 9.1 iAssign functionality

Read tag



Select the read tag menu option.

The touch tag to phone message will display. Touch the tag against the back of the device.

The tag information will display.

Note: If the device is unable to read the tag, a red X will display. Try reading the tag again. Verify that no objects are between the tag and the phone or tablet and that NFC is turned on for the device.

Tap the edit button to make changes to the user or site associated with the tag (see *Write Tag*).

Write tag

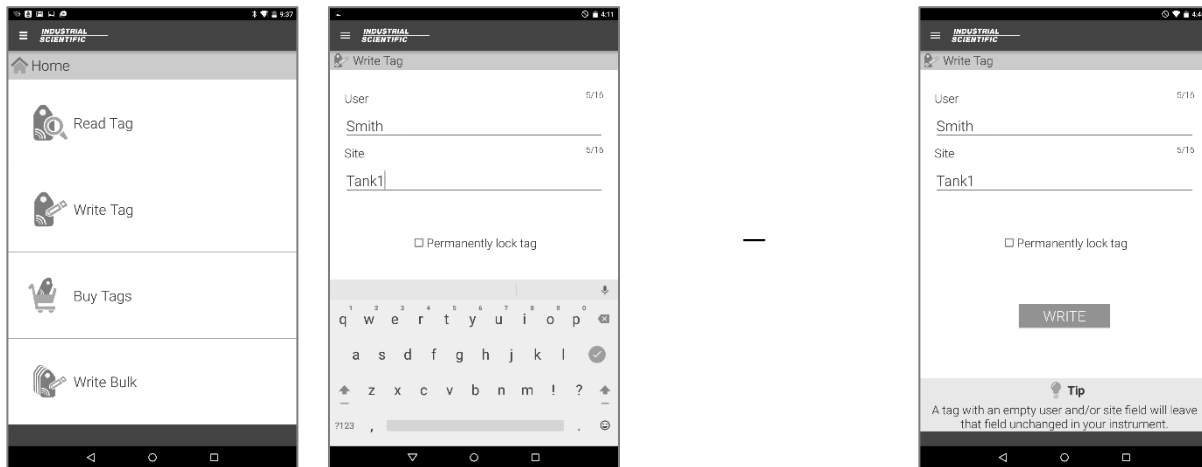

Select the write tag menu.

The write tag screen will display.

Tap in the user field to edit the user.

Tap in the site field to edit the site.

If either a user or site should not be assigned, leave the corresponding field blank.

Click the permanently lock tag check box to prevent future edits to the tag data.

Tap the Write button to save the user and site settings.

Table 9.1 iAssign functionality

Buy tags

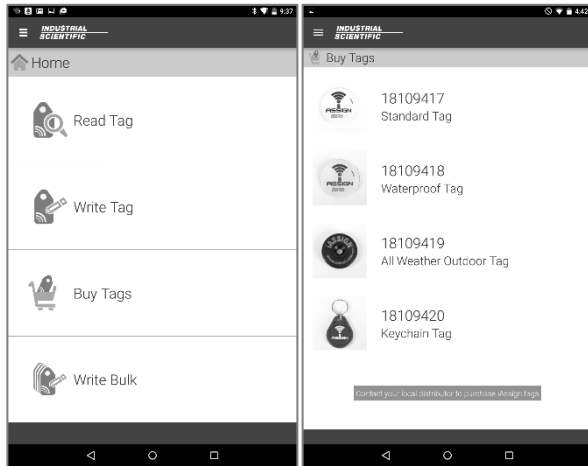

Select the buy tags menu.

A list of available tags will display. Available tag types include:

Standard tag: A lightweight, adhesive tag that can be attached to an ID badge or other clean, flat surface.

Waterproof tag: A lightweight, adhesive tag with a waterproof coating that can be attached to an ID badge or other clean, flat surface.

All weather outdoor tag: A durable plastic tag with a center screw hole. The tag is appropriate for permanent installation indoors or out.

Keychain tag: A lightweight tag that can be attached to keys.

Write bulk

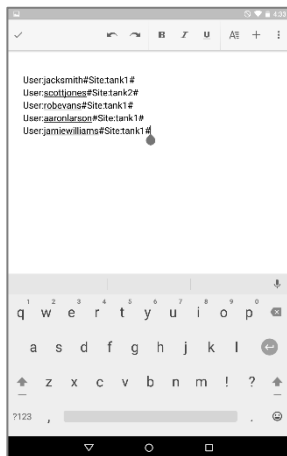

Create a file containing all necessary user and site assignments following the format:

User:johndoe#Site:tank1# where "johndoe" is the user name and "tank1" is the location.

There are no spaces in the text string. The words "User" and "Site" must be capitalized.

The file can be created in any word processing, e-mail, or spreadsheet software.



Copy the text to the device clipboard.

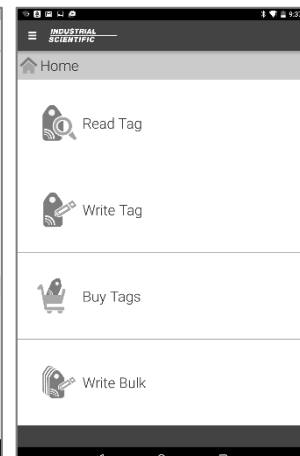

In iAssign, select the write bulk menu option.

Table 9.1 iAssign functionality

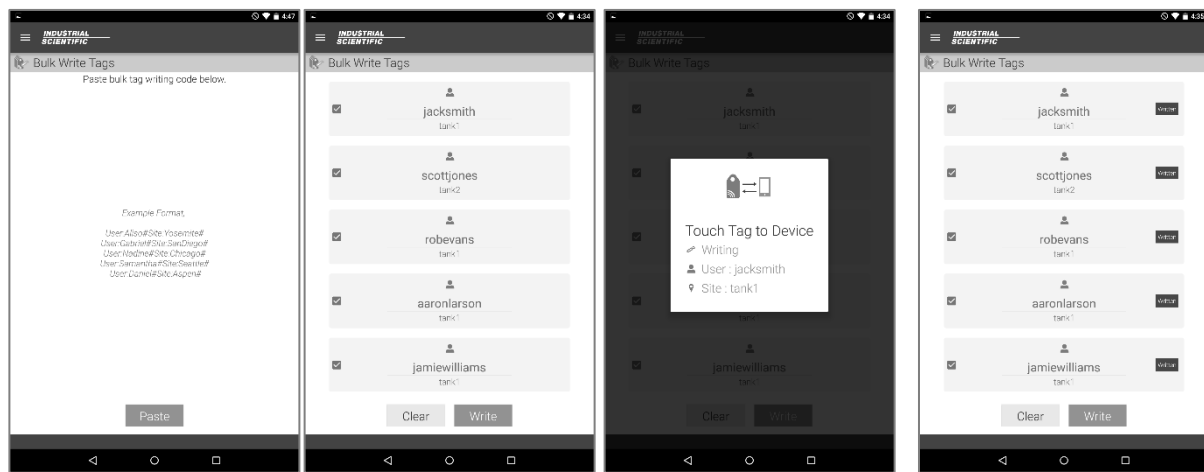

Tap the paste button.

The contents of the file will display. Tap the write button to assign the first tag.

Touch the first tag to the back of the device. A confirmation window will appear indicating that the assignment was successful.

Repeat touching tags to the back of the device until all assignments are complete.

Transfer assignments to a Ventis Pro Series instrument



To transfer the user and site assignment data to a Ventis Pro Series instrument, touch the NFC tag to the front of the instrument.

When an assignment is successfully made, the instrument will emit an ascending tone, flash blue lights, and show the new user-site on the display screen.

Remove assignments from a Ventis Pro Series instrument



To remove the user and site assignment data from a Ventis Pro Series instrument, touch the same NFC tag to the front of the instrument a second time.

The instrument will display a user and site screen with the assignments removed.

Alternatively, power off the instrument. Assignments made using iAssign are cleared when the instrument is powered off. To assign an instrument for an extended period of time, complete the assignment using iNet, DSSAC, or Accessory Software.

Appendix

Supplemental Information about Gases and Sensors

Toxic Gases

A sensor is designed to detect for and measure the presence of a particular gas, the "target gas"; however, it may also respond to other gases. When this is the case, the sensor is said to have "cross-sensitivity" to another gas, which will interfere with the target-gas readings. Table A.1 provide insight to the levels of cross sensitivity that can exist and whether a nontarget gas will have the effect of adding to or subtracting from the target-gas readings.

For example, a site is being monitored for H₂S; the air also contains NO₂. According to table A.1, the H₂S sensor will respond to NO₂, so the H₂S readings will account for both gases. Because the NO₂ cross-sensitivity value is negative (-25%), its presence will *subtract from* the H₂S readings, which will generate an H₂S reading that is *lower* than the actual concentration of H₂S contained in the air sample.

When a cross-sensitivity value is positive, the opposite will happen. When a gas has a positive cross-sensitivity value, it will add to a sensor's target gas reading, which will generate a reading that is higher than the actual concentration of the target gas contained in the air sample.

Table A.1 Cross-sensitivity guidelines (%)

Target Gas	Sensor						
	CO	CO/H ₂ Low	H ₂ S	SO ₂	NO ₂	HCN	NH ₃
CO	100	100	1	1	0	0	0
H ₂ S	5	5	100	1	-40	10	25
SO ₂	0	5	5	100	0	—	-40
NO ₂	-5	5	-25	-165	100	-70	-10
Cl ₂	-10	0	-20	-25	10	-20	-50
ClO ₂	—	—	—	—	—	—	—
HCN	15	—	—	50	1	100	5
HCl	3	—	—	5	0	0	0
PH ₃	—	—	—	—	—	425	—
NO	25	40	-0.2	1	5	-5	0
H ₂	22	3	0.08	0.5	0	0	0
NH ₃	0	0	0	0	0	0	100

The values supplied above are estimates. They generally apply only to new sensors used for monitoring gases in these environmental conditions: 20 °C (68 °F), 50% RH, and 1 atm. Values are subject to change.

“—” indicates no available data.

Combustible Gases

Tables A.2 and A.3 provide the LEL for select combustible gases as they apply to specific sensors. These tables also provide correlation factors that can help determine the percentage LEL when the actual gas differs from the gas that was used to calibrate the instrument.

For example, if the instrument reads 10% LEL in a pentane atmosphere, and was calibrated to methane, the actual percentage LEL is determined as follows:

1. Locate the table cell where the sample gas (pentane) intersects with the calibration gas (methane).
2. Multiply the cell's value (2.02) by the unit's LEL reading (10%) to calculate the actual concentration of 20.2% LEL.

Table A.2 LEL correlation factors for the sensors 17155304-K, -L, and -M

Sample gas	LEL (% vol)	Calibration gas					
		Butane	Hexane	Hy- drogen	Methane	Pentane	Propane
Acetone	2.5%	1.00	0.70	1.70	1.70	0.90	1.10
Acetylene	2.5%	0.70	0.60	1.30	1.30	0.70	0.80
Benzene	1.2%	1.10	0.80	1.90	1.90	1.00	1.20
Butane	1.9%	1.00	0.58	1.78	1.67	0.83	1.03
Ethane	3.0%	0.80	0.60	1.30	1.30	0.70	0.80
Ethanol	3.3%	0.89	0.52	1.59	1.49	0.74	0.92
Ethylene	2.7%	0.80	0.60	1.40	1.30	0.70	0.90
Hexane	1.1%	1.71	1.00	3.04	2.86	1.42	1.77
Hydrogen	4.0%	0.56	0.33	1.00	0.94	0.47	0.58
Isopropanol	2.0%	1.10	0.90	2.00	1.90	1.00	1.20
Methane	5.0%	0.60	0.35	1.06	1.00	0.50	0.62
Methanol	6.0%	0.60	0.50	1.10	1.10	0.60	0.70
Nonane	0.8%	2.22	1.30	3.95	3.71	1.84	2.29
Pentane	1.4%	1.21	0.71	2.15	2.02	1.00	1.25
Propane	2.1%	0.97	0.57	1.72	1.62	0.80	1.00
Styrene	0.9%	1.30	1.00	2.20	2.20	1.10	1.40
Toluene	1.1%	1.53	0.89	2.71	2.55	1.26	1.57
Xylene	1.1%	1.50	1.10	2.60	2.50	1.30	1.60
JP-4	—	—	—	—	—	1.20	—
JP-5	—	—	—	—	—	0.90	—
JP-8	—	—	—	—	—	1.50	—

Table A.3 LEL correlation factors^a for the sensor 17155304-U

Sample gas	Calibration gas	
	LEL (% vol)	Propane
Acetone	2.5	3.28
Butane	1.9	0.97
Chloromethane	8.1	0.966
Cyclopentane	1.1	1.62
Dichloroethane	5.4	8.57
Ethane	3.0	1.01
Ethanol	3.5	1.65
Ethyl Acetate	2.0	1.69
Ethylene	2.7	3.43
Ethylene Oxide	3.0	0.845
Hexane	1.1	0.8
Isopropanol	2.0	1.43
Methane	5.0	3
Methanol	6.0	2.22
Methyl ethyl ketone	1.4	1.87
Pentane	1.4	0.89
Propylene	2.4	1.69
Toluene	1.1	1.18
Xylene	1.1	1.51

^aThese factors only apply to gas concentrations expressed in % volume terms and up to 2.5%vol. These factors may vary from sensor to sensor with tolerance of $\pm 25\%$ deviation.

Contact Information

Industrial Scientific Corporation

1 Life Way
Pittsburgh, PA 15205-7500 USA
Web: www.indsci.com
Phone: +1 412-788-4353 or 1-800-DETECTS (338-3287)
E-mail: info@indsci.com
Fax: +1 412-788-8353

Industrial Scientific France S.A.S.

5 Rue Frédéric Degeorge, CS 80097
62002 Arras Cedex, France
Web: www.indsci.com
Téléphone : +33 (0)1 57 32 92 61
E-mail: info@eu.indsci.com
Fax: +33 (0)1 57 32 92 67

英思科传感仪器（上海）有限公司

地址：中国上海市浦东金桥出口加工区桂桥路290号
邮编：201206
电话：+86 21 5899 3279
传真：+86 21 5899 3280
E-mail： info@ap.indsci.com
网址： www.indsci.com
服务热线：+86 400 820 2515

To locate a nearby distributor of our products or an Industrial Scientific service center or business office, visit us at www.indsci.com.

Rendez-vous sur notre site Web www.indsci.com, si vous voulez trouver un distributeur de nos produits près de chez vous, ou, si vous recherchez un centre de service ou un bureau Industrial Scientific.

Besuchen Sie uns unter www.indsci.com, um einen Vertriebshändler unserer Produkte oder ein Servicecenter bzw. eine Niederlassung von Industrial Scientific zu finden.

Para buscar un distribuidor local de nuestros productos o un centro de servicio u oficina comercial de Industrial Scientific, visite www.indsci.com.

如需查找就近的产品经销商或 Industrial Scientific 服务中心或业务办事处，请访问我们的网站 www.indsci.com。

INDUSTRIAL

SCIENTIFIC